

KORG

Owner's Manual

opsix

ALTERED FM SYNTHESIZER

opsix SE

ALTERED FM SYNTHESIZER

opsix module

ALTERED FM SYNTHESIZER

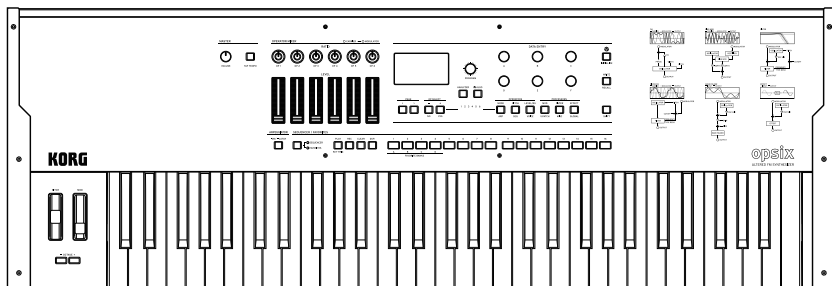
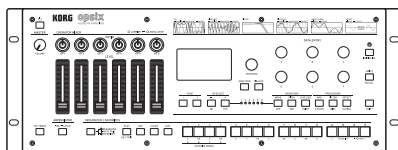
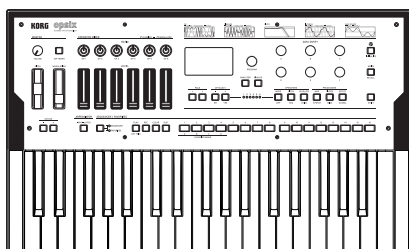

Table of Contents

Introduction	6
1. Main Features	6
2. About the sound generator of the opsix	7
Operator (modulator, carrier)	7
Algorithms	7
Operator modes	7
3. Block Diagram	11
Panel description and functions	12
1. Front panel	12
2. Rear panel connections	16
Connecting the AC adapter	17
Other connections	17
Operation Guide	18
1. Turning the power on/off	18
Turning the opsix On	18
Turning the opsix Off	18
Auto Power-Off	19
2. Playing the opsix	20
Selecting a program to use when playing	20
Using the analyzer	22
Performing with the arpeggiator	22
3. Editing the programs	24
Editing with the OPERATOR MIXER	24
Easy program editing	25
Randomized editing	25
Detailed editing	26
Saving a program	27
Initializing a program	29
Canceling the program edits	29

4. Using the step sequencer.....	30
How the sequencer works	30
Playback and recording on the step sequencer.....	31
Step recording.....	31
Recording motions to the motion sequencer with the knobs and sliders.....	32
Editing sequence data.....	32
 Parameter Guide.....	 35
List of parameters	35
HOME/ALGO	42
HOME/ALGO (Home/Algorithm)	42
OPERATORS: MODE.....	43
MODE: OP1...6 (Operator Mode)	43
OPERATORS: PITCH	50
PITCH: OP1...6 (Operator Pitch).....	50
P MOD: OP1...6 (Operator Pitch Modulation).....	51
OPERATORS: LEVEL/EG	52
EG: OP1...6 (Operator Level/EG)	52
KTRK: OP1...6 (Operator Level Key Track).....	53
L MOD: OP1...6 (Operator Level Modulation).....	54
MOD	55
EG1 PITCH, EG2 FLTR (Filter), EG3 (Assignable).....	55
LFO1 OP (Operators), LFO2 FLTR (Filter), LFO3 (Assignable).....	55
FILTER.....	58
FILTER.....	58
FLTR MOD (Filter Modulation)	60
EFFECT	61
FX 1, 2, 3 (Effect 1, 2, 3).....	61
ARP (Arpeggiator).....	62
ARPEGGIATOR.....	62
SEQ (Sequencer).....	64
SEQUENCER.....	64
SEQ NOTE (Sequencer Note)	65
MOTION	66
SEQ UTIL (Sequencer Utility)	67
VOICE	69
VOICE (Voice Assign).....	69

V.PATCH	71
V.PATCH 1...12 (Virtual Patch 1...12).....	71
MISC	72
PROG PITCH (Program Pitch).....	72
PROG MISC (Program Misc)	73
USER ALG (User Algorithm)	73
OP UTIL (Operator Utilities)	75
GLOBAL	76
TUNE	76
MIDI.....	76
CTRL (Controller)	79
SEQ	81
SYS.....	82
Algorithm List	83
Waveform List	84
Control Source List	85
Motion Destination List	86
Virtual Patch Source List	88
Virtual Patch Destination List	89
Effect Parameter List	91
Appendix	95
Connecting the opsix to a MIDI device or computer	95
Connecting/ a computer or MIDI device	95
MIDI-related settings	97
Librarian software	98
Loading DX7 sounds	99
System exclusive messages that can be loaded	99
Receiving DX7 system exclusive messages	99
Restoring the opsix to factory-set default settings	101
Troubleshooting	103
Specifications	105
Program Name List	107
Favorite List	115
MIDI Implementation Chart	116

About this manual

- **The owner's manuals and how to use them**

The opsix comes with the following manuals.

- Precautions (for opsix only: printed and PDF)
- Quick Start Guide (printed and PDF)
- Owner's Manual (this document, PDF)

You can download these PDF manuals from the Korg website (www.korg.com).

- **Conventions in this manual**

- Indication of parameters

Parameters shown in the display are indicated in quotation marks.

- Symbols, , **Note**, **Tip**

These symbols respectively indicate a caution, a supplementary note, or a tip.

- Example screen displays

The parameter values shown in the example screens of this manual are only for explanatory purposes, and may not necessarily match the values that appear in the LCD screen of your instrument.

- MIDI-related explanations

CC# is an abbreviation for Control Change Number. In explanations of MIDI messages, numbers in square brackets [] always indicate hexadecimal numbers.

- About the opsix, opsix SE and opsix module

This Owner's Manual applies to the opsix, opsix SE and opsix module. Explanations in this manual that are marked as "opsix SE only" or "opsix module only" apply only to those products.

The panel illustrations and display examples used in this manual are from the opsix, but the display and operations are basically the same on the opsix SE and opsix module as well. If you are using the opsix module, any mentions in this manual related to operating the keyboard should be read as operating an external MIDI keyboard.

COPYRIGHT WARNING

- This professional device is intended only for use with works for which you yourself own the copyright, for which you have received permission from the copyright holder to publicly perform, record, broadcast, sell, and duplicate, or in connection with activities which constitute "fair use" under copyright law. If you are not the copyright holder, have not received permission from the copyright holder, or have not engaged in fair use of the works, you may be violating copyright law, and may be liable for damages and penalties. **KORG TAKES NO RESPONSIBILITY FOR ANY INFRINGEMENT COMMITTED THROUGH USE OF KORG PRODUCTS.**
- The content that is built into this product or included with it may not be extracted, recorded, or stored in a form similar to its original state, and distributed or made publicly available on the internet. The content of this product (such as sound programs, style data, accompaniment patterns, MIDI data, PCM sample data, audio data, operating system etc.) is the copyrighted property of KORG Inc. or is copyrighted material used by KORG Inc. under license from a third party. You do not need permission from KORG Inc. to use the above content to produce or perform musical works, or to record and distribute such works.

* All product names and company names are the trademarks or registered trademarks of their respective owners.

Introduction

Thank you for purchasing the Korg **opsix/opsix SE/opsix module** altered FM synthesizer. To help you get the most out of your new instrument, please read this manual carefully.

1. Main Features

- The opsix features an FM sound generator that produces complex harmonics by rapidly modulating the basic waveforms of its oscillators using other oscillators.
- In addition to FM synthesis, the opsix also features various Operator modes such as a ring modulator, wavefolder, Effect and so on. The six Operators can be combined to create a wide variety of sounds.
- You can use the OPERATOR MIXER (with sliders and knobs) to directly control the parameters of each Operator. This is useful for intuitive editing and making dynamic sound changes when you are performing.
- The opsix includes a rich selection of filters including Polysix and MS-20 models, which covers the bases for making sounds like those generated with subtractive synthesis.
- Three high-definition multi-effects are available, and you can select from 30 types for each.
- 500 programs (350 preset programs and 150 user programs as the factory-set default) can be called up and saved in an instant.
- Powerful 16-step polyphonic sequencer.
- A spectrum analyzer and an oscilloscope that let you visualize your sound.
- The opsix SE features a 61-key keyboard with aftertouch. Aftertouch is an effect that's applied when you play a key and then press into the keyboard further while holding the key down. The more you press into the key, the stronger the effect. Aftertouch is generally used to control the volume, the sound (cutoff frequency) and the LFO sensitivity.
- The opsix module has a note trigger function that lets you use the STEP 1–13 buttons to play instead of using the keyboard.
- This unit supports some MIDI 2.0 functions (Property Exchange), and can interact with compatible MIDI devices. (Supported in system ver.3.1.0 and later.) For details, visit the Korg website (www.korg.com).

2. About the sound generator of the opsix

The principles of FM sound generation were discovered and established by Dr. John Chowning at Stanford University in the 1970s, when he was experimenting with vibrato. FM sound generation was later packaged into an LSI chip and put into practical use by Yamaha Corporation. From the beginning of the 1980s, FM tone generation was used as an internal sound source on the DX series, personal computers, game machines and cellphones.

Operator (modulator, carrier)

The FM (Frequency Modulation) sound generator is based on synthesis elements called “Operators.” Operators are modulated using simple input waveforms (WAVE) such as sine waves, outputting sounds with complex harmonics. Operators can act as either a modulator or a carrier. The output sound from a modulator feeds into another Operator and modifies that Operator’s output.

Carriers receive the output sound from modulators and output the modulated result as audio.

Algorithms

In the FM sound generator, the combination of the roles and connections of the Operators is called an “algorithm.” Selecting an algorithm is a good starting point for creating sound. The opsix sound generator includes six Operators, and more than 40 preset algorithms are provided. You can use the user algorithm function to create new combinations as well.

Operator modes

Although the basis of the opsix is the FM sound generator, you can change the Operator mode to perform different kinds of modulation besides FM. The combination of ring modulator, filter, and wavefolder makes it possible to create new kinds of sounds that surpass the range of typical FM sounds.

An Operator includes an input, an output and an oscillator. The carrier’s Operator mode determines how the oscillator is modulated by the input of the modulator. This modulation gives the sound its character. To add to the FM, Ring Mod, Filter, Filter FM, Wave Folder and Effect Operator modes, the opsix features Mute and Bypass modes that are useful when editing.

Algorithm example
(preset algorithm 1)

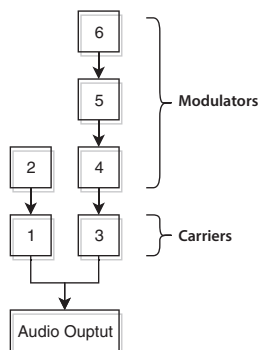

What happens when modulators modulate the carriers

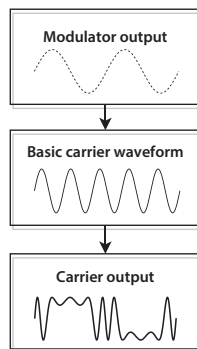

FM

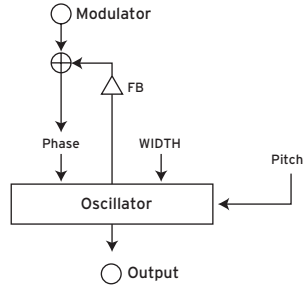
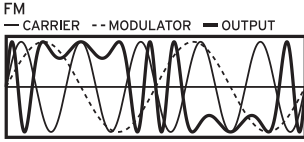

As an example, when the LFO is used to raise and lower the pitch, you will hear a vibrato-like effect. FM (Frequency Modulation) is an ultra high-speed vibrato. The phase of an oscillator is modulated using the input signal from the modulator, which rapidly raises and lowers its pitch. (This works the same as Korg's VPM tone generator and typical FM synthesizers.)

As modulation is incredibly fast, we hear the result not as vibrato, but as a change in tone.

In this Operator mode, we can use the FB and WIDTH parameters to control the amount of self-feedback and the width of the oscillator waveform.

- Typical program: 057: Strum Down, 327: [TMP] 2OP FM

Ring Mod.

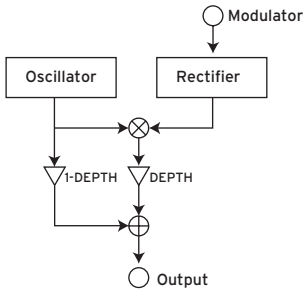
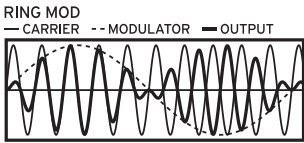

Modulating the amplitude of a signal creates tremolo. Ring modulation, or Ring Mod for short, is ultra-fast tremolo. It is historically called this because of the shape of the electrical circuit originally used to create the effect. The input signal from the modulators are multiplied with the carrier oscillator to rapidly change the amplitude of the signal. As with FM, the extremely fast modulation is perceived as a change in tonal character. The input from the modulator(s) can be processed by a rectifier, where the "SHAPE" parameter controls the amount of rectification. The larger the value, the more overtones will be added.

- Typical program: 134: Ring It On, 331: [TMP] Ring Mod

Filter

FILTER

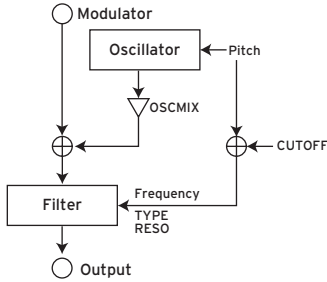
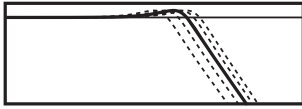

This is a filter with a key tracking function. The input signals from the oscillator and modulator(s) are input into the filter. The “OSCMIX” parameter controls the amount of the oscillator signal fed to the filter. The cutoff frequency is synchronized to the oscillator pitch and the “CUTOFF” parameter adds an offset.

- Typical program: 178: Formant Pad, 324: [TMP] Reso Noise

Filter FM

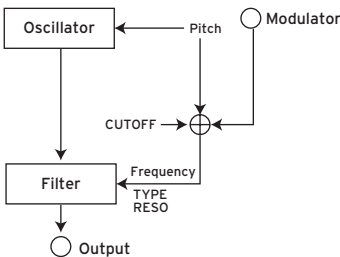
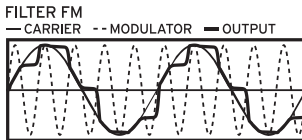

Modulating a filter’s cutoff with an LFO creates an effect like a wah pedal. Filter FM creates an ultra high-speed wah effect. The cutoff frequency is modulated using the input signals from the modulator(s), and the oscillator signal is used as audio input for the filter. As with Filter mode, the modulation center frequency is synchronized with the oscillator pitch, and you can use the CUTOFF parameter to add an offset.

- Typical program: 157: FilterFM Pad, 335: [TMP] Filter FM

Wave Folder

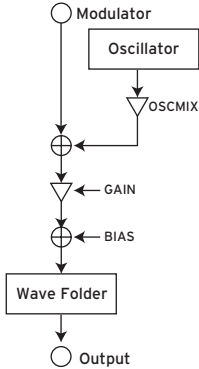
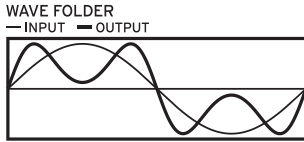

This is a waveshaping effect. The wave folder circuit generates harmonics by inverting the waveform of the input signals from the oscillator and the modulator at a fixed threshold. The “OSCMIX” parameter controls the amount of the oscillator signal fed into the wavefolder.

- Typical program: 024: Dynamik, 334: [TMP] Wavefolder

Effect

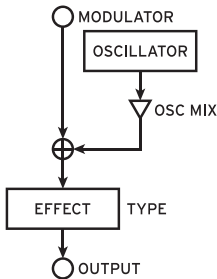
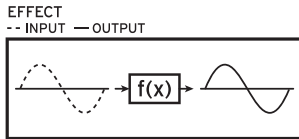

In this mode, the operator functions as an effect like delay, comb filter or distortion. The signal from the oscillator and the input signal from the modulator are inputted into the effect. The OSCMIX parameter controls the input level of the oscillator. Other effect parameters differ depending on the type of effect you select.

- Typical program:

Peaking EQ	020: Ana Eleki Piano, 240: Dirty Trautonium
Shelving EQ	311: KONG's Footstep
Phaser	087: Snow Ball, 340: [TMP] Phaser Noise
Short Delay	314: Delay Modulator, 337: [TMP] Delay Mod
Comb Filter	022: Comb Piano, 338: [TMP] Comb Flanger
Distortion	238: Thick Screamer, 266: Purple Dist EG
Drive	237: Cinematic FB Doom
Decimator	313: Cockpit Emergency
Waveshaper	007: Waveshape EP, 336: [TMP] Waveshape
Punch	009: Punchy Wire Piano, 086: FM Airy Bell

3. Block Diagram

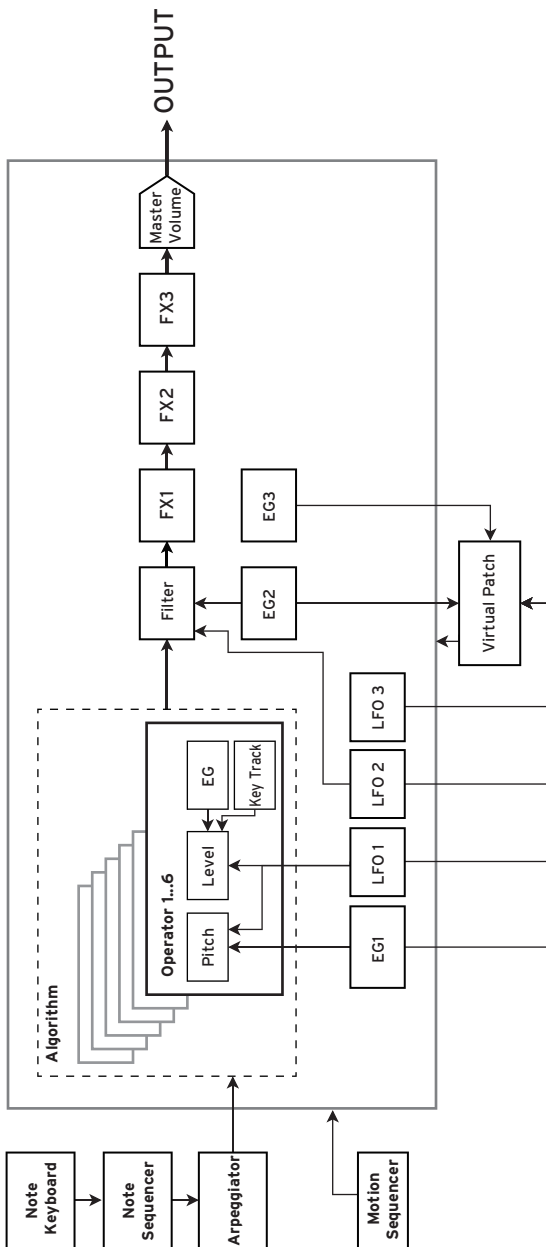

Panel description and functions

1. Front panel

- opsix

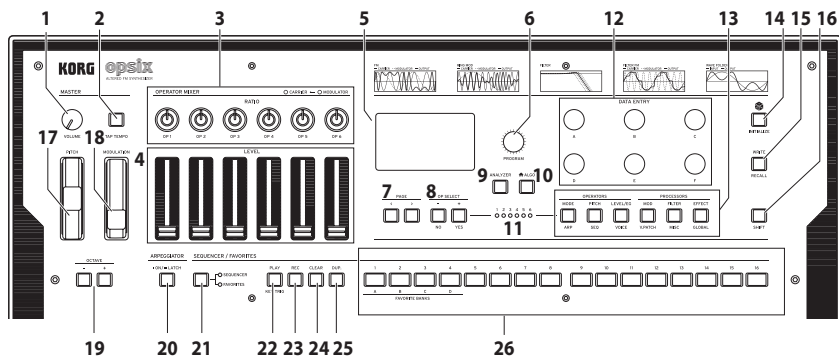

- opsix SE

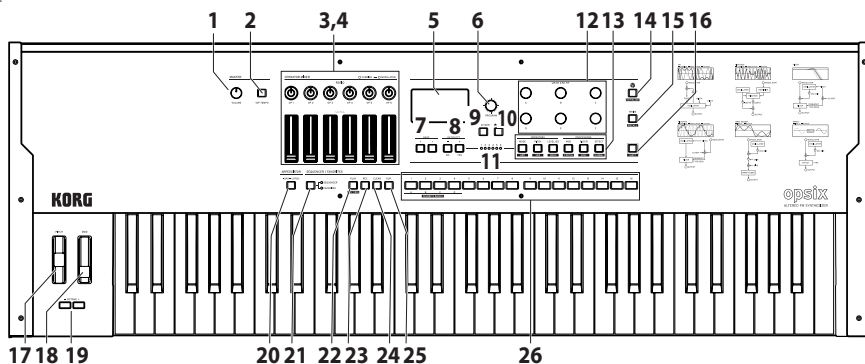

- opsix module

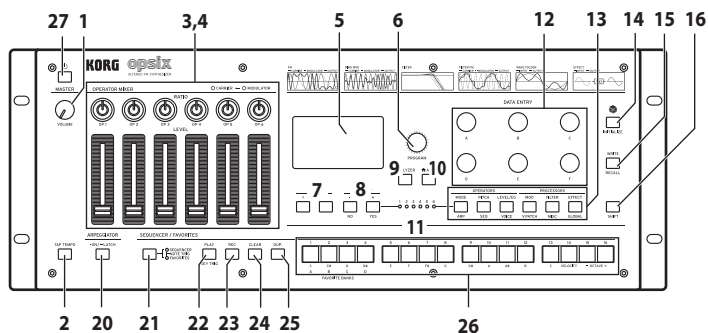

1. VOLUME knob

This adjusts the volume of the AUDIO OUTPUT jacks (L/MONO, R) and headphone jack.

2. TAP TEMPO button

During playback, you can enter a tempo manually by lightly tapping this button a few times at the desired tempo (Tap Tempo).

3. RATIO OP 1–6 knobs

These knobs change the pitch of each Operator. Operate the knobs while holding down the SHIFT button to change the Operator modes. See “Editing with the OPERATOR MIXER”, p.24.

4. LEVEL OP 1–6 sliders

These sliders change the output level of each Operator. Operate the sliders while holding down the SHIFT button to change the oscillator waveforms. See “Editing with the OPERATOR MIXER”, p.24.

5. Display

This shows various information such as program data and parameter values.

6. PROGRAM knob

Selects the program. See “Selecting a program to use when playing”, p.20.

7. PAGE < and > buttons

Use the < and > buttons to switch between edit pages.

These are enabled when the page guide is shown in the display.

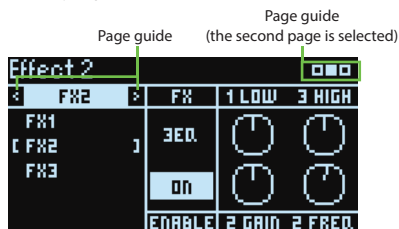

8. OP SELECT +/- buttons and YES/NO buttons

Use these buttons to select the Operator to edit. These are also used to select (YES) or cancel (NO) items in a list or when saving programs.

9. ANALYZER button

Switches the display to the spectrum analyzer and oscilloscope. See “Using the analyzer”, p.22.

10. HOME (ALGO) button

Displays the HOME/ALGO page.

11. Operator select LEDs

The selected Operator will light up when the Operator edit page (MODE, PITCH, LEVEL) is displayed.

12. DATA ENTRY A–F knobs

These knobs change the parameter values shown in the display. Hold down the SHIFT button while turning a knob to make fine-tune changes to the value. See “Easy program editing”, p.25.

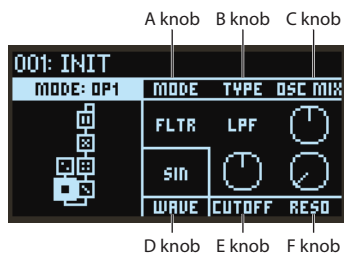

13. EDIT SELECT button

These buttons change the edit page shown on the display. Press while holding the SHIFT button down to display the page shown below the buttons.

14. (Randomize) button

This begins randomized editing. Hold down the SHIFT button while pressing this button to initialize the program. See “Randomized editing”, p.25.

15. WRITE button

Saves the settings for the edited program. Hold down SHIFT while pressing this button to revert the settings of the program you are editing to the saved state. See “Saving a program”, p.27.

16. SHIFT button

This button lets you access extended functions for the knobs and buttons. Also, the current value of each parameter shown will be indicated on the display for a while after SHIFT is pressed. Double-click the SHIFT button to hold the SHIFT state. Press SHIFT again to cancel the hold.

17. PITCH wheel

Excluding the opsix module: Controls the pitch of the sound.

18. MODULATION wheel

Excluding the opsix module: This wheel is generally used to control the cutoff frequency or vibrato depth. You can also change which parameters are controlled by the wheel.

19. OCTAVE buttons

Excluding the opsix module: These shift the range of notes assigned to the keyboard up or down in one-octave steps over a range of four octaves.

20. ARPEGGIATOR button

Switches the arpeggiator on/off. Hold this down to turn the arpeggiator latch function on/off. See “Performing with the arpeggiator”, p.22.

21. SEQUENCER/FAVORITES button

Selects the function that will be used by the STEP 1–16 buttons. When SEQUENCER is selected, the buttons will act as step buttons for the step sequencer. See “Playback and recording on the step sequencer”, p.31. When FAVORITE is selected, you can assign the programs you like to the STEP 1–16 buttons and recall them instantly. See “FAVORITE function”, p.21.

opsix module only: When NOTE TRIGGER is selected, you can use the STEP 1–16 buttons to play notes instead of the keyboard. See “Note trigger function”, p.21.

22. PLAY button

This starts and stops playback of the step sequencer. When switching to playback, the sequencer will always be reset to the first step. While holding down the SHIFT button, press the PLAY button to set key trigger mode. To set key trigger to latch, long-press the PLAY button while holding down the SHIFT button.

23. REC button

Enters step sequencer recording mode. When the sequencer is stopped, this will begin step recording; and when the sequencer is playing back, this will begin real-time recording.

24. CLEAR button

When the step sequencer is playing back, the sequence will be muted while this button is pressed. Pressing the button in real-time recording will delete the notes that play during that time. At any other time, you can hold down this button and press a step that you want to delete using the STEP 1–16 buttons. See “Selecting steps to be muted”, p.33.

25. DUP. button

To copy a selected step to another step, hold down this button and press the copy source and destination steps using the STEP 1–16 buttons. See “Copying step information”, p.32.

26. STEP 1–16 buttons

If you press the SEQUENCER/FAVORITES button while SEQUENCER is selected, you can turn steps on/off in the step sequencer, edit the sequence data or select the steps displayed. See “4. Using the step sequencer”, p.30.

If FAVORITES is selected, you can use the STEP 1–16 buttons to recall the programs you registered. See “FAVORITE function”, p.21.

27. Power button

opsix module only: Turns the power on/off. See “1. Turning the power on/off”, p.18.

2. Rear panel connections

- opsix

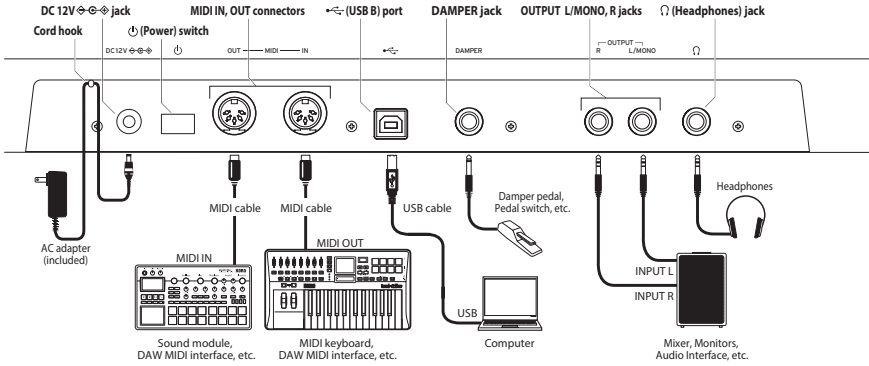

- opsix SE

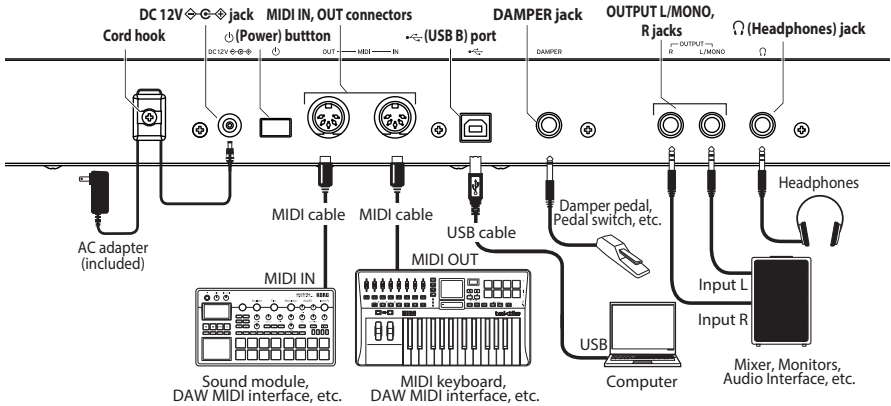

- opsix module

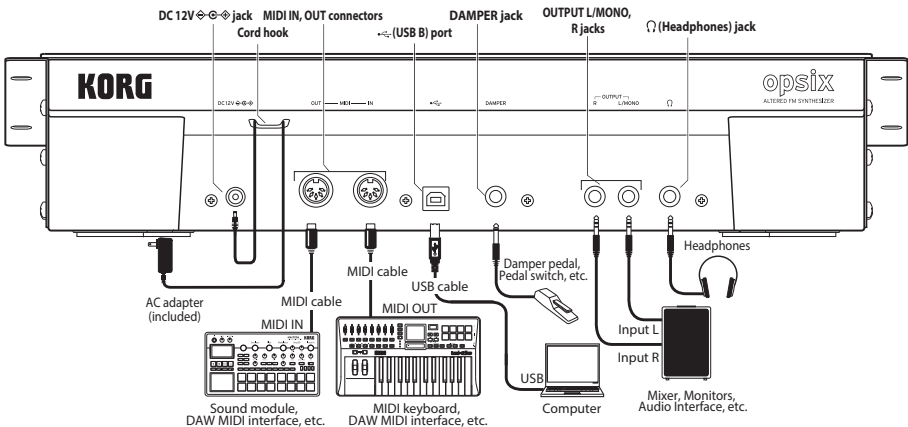

Connecting the AC adapter

1. Connect the DC plug of the included AC adapter to the DC 12V jack on the rear panel of the opsix.
 - ⚠ Be sure to use only the included AC adapter. Using any other AC adapter may cause malfunctions.
2. After connecting the DC plug, loop the AC adapter cord onto the Cord Hook.
 - ⚠ Do not use excessive force when pulling the cord off the hook. Doing so may damage the plug.
3. Connect the plug of the AC adapter to an AC outlet.
 - ⚠ Be sure to use an AC outlet of the correct voltage for your AC adapter.

Other connections

Connect the devices as appropriate that you will use.

- ⚠ Be sure that the power on all of your devices is turned off before you make connections. Leaving the power on when you make connections may cause malfunctions, or damage your speaker system and other components.

Audio equipment

OUTPUT L/MONO, R jacks (impedance-balanced 6.3 mm TRS phone jacks): Connect these TRS jacks to a mixer, audio interface, monitor system, etc. Adjust the volume level using the VOLUME knob.

🎧 **(headphone) jack** (6.3 mm stereo phone jack): Connect the headphones here. This carries the same signal as that of OUTPUT L/MONO and R.

Pedal

DAMPER jack (6.3 mm phone jack, half-damper not supported): Connect a Korg DS-1H damper pedal or a PS-1/PS-3 pedal switch (sold separately) to control the damper function. Pedal polarity is detected automatically; to allow this, make sure that the pedal is not held down when connected, or while turning on power.

MIDI device

MIDI IN, OUT connectors: Use these connectors to connect the opsix to an external MIDI device for exchanging MIDI messages. Make sure that the MIDI channels are set appropriately. (See “Connecting/ a computer or MIDI device”, p.95)

Computer

USB B port: Connect this to a computer to exchange MIDI messages and data. (See “Connecting the opsix to a computer via USB”, p.95)

- ⚠ For the following terminals, use a cable of 3 m or less to prevent malfunction.
 - 🎧 (headphones) jack, DAMPER jack, USB-B port

Operation Guide

1. Turning the power on/off

Turning the opsix On



Make sure that both the opsix and any amplification devices such as powered monitor speakers are turned off, and turn the volume of all devices all the way down.

1. Press the  (Power) button on this instrument. Once the “opsix” logo appears in the display, take your finger off the  (Power) button.



2. Turn on any amplification devices such as powered monitor speakers, and then adjust their volume. Adjust the opsix’s volume using the VOLUME knob.

Turning the opsix Off

1. Lower the volume of your powered monitors or other amplification devices, and turn them off.
2. Press the opsix  (power) button until the display shows “Shutting down,” and then release the  (power) button.

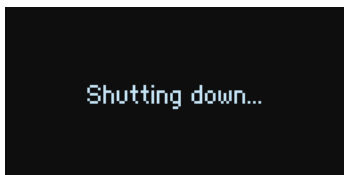

Auto Power-Off

By default, the opsix will automatically turn off after about four hours have elapsed without use of the front panel, keyboard, or MIDI input.

Disabling the auto power-off function

1. Hold down the SHIFT button and press the EFFECT/GLOBAL button.

Global Parameters		
Cat.	Param.	Val.
TUNE	Master Tune	0ct
MIDI	Transpose	0
CTRL		
SEQ		

2. Use the DATA ENTRY A knob to select "SYS."
3. Use the DATA ENTRY B knob to select "Auto Power-Off"

Global Parameters		
Cat.	Param.	Val.
SYS	Auto Power Off	4H
	Screen Bright	10
	LED Bright	10
	System ID	1

4. Use the DATA ENTRY C knob to select "Off."

Global Parameters		
Cat.	Param.	Val.
SYS	Auto Power Off	Off
	Screen Bright	10
	LED Bright	10
	System ID	1

2. Playing the opsix

Selecting a program to use when playing



1. Turn the PROGRAM knob to select a program.

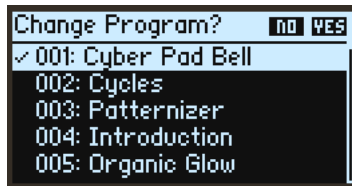

2. Play the keyboard to check the sound.
Adjust the volume level using the VOLUME knob.
3. To confirm that this is the program you want to select, press the YES button.
To cancel the selection and return to the previous program, press the NO button.
Tip: When the program list is shown, you can press the PAGE < and > buttons to switch between each sound.
4. *Excluding the opsix module:* To change the tonal range of the keyboard, press the OCTAVE button. You can change the octave within a range of ± 4 octaves.

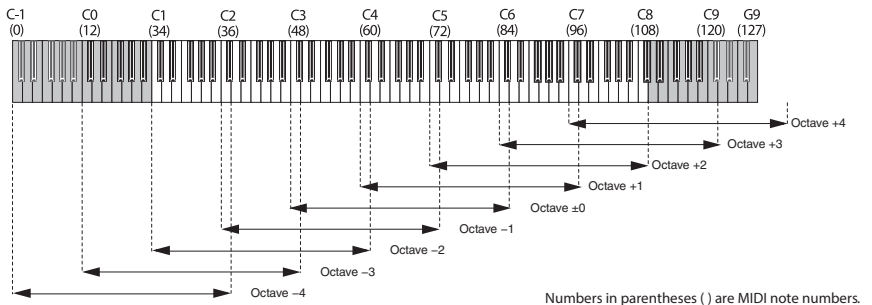

5. *Excluding the opsix module:* Use the PITCH wheel to change the pitch. The MODULATION wheel modifies whatever parameter is has been assigned to it. It is often used to change the cutoff frequency or vibrato depth. You can also change which parameters are controlled by the MODULATION wheel.

FAVORITE function

Use the FAVORITE function to register and then quickly change programs with the STEP 1–16 buttons.

1. Press the SEQUENCER/FAVORITES button to select FAVORITES.

2. Press one of the STEP 1–16 buttons to switch to the sound registered to that button.



3. While holding down the SHIFT button, press one of the STEP 1–4 buttons (FAVORITE BANK A–D) to switch FAVORITE banks.

There are four favorite banks from A to D, and you can register 16 programs corresponding to the STEP 1–16 buttons per bank.

- **Registering a favorite**

Press the SEQUENCER/FAVORITES button to select FAVORITES. After selecting a program to register in a STEP button, hold down the WRITE button and press the STEP button you want to register.

Note trigger function

opsix module only: You can use the step buttons on the opsix module to check the program sounds and record using the step sequencer.

- **Performing with the step buttons**

When you press the SEQUENCER/FAVORITES button to make both the SEQUENCER and FAVORITES LEDs light up, and then select NOTE TRIGGER, the note trigger function is enabled. This lets you use the STEP 1–13 buttons instead of the keyboard.



The STEP 1–13 buttons cover a one-octave range, and they light up to indicate black and white keys. Use the STEP 15, 16 buttons to shift the octave up/down in one-octave steps over a range of four octaves. Use the STEP 14 button to toggle the velocity.

To stop using the STEP 1–13 buttons as a keyboard, press the SEQUENCER/FAVORITES button to select either SEQUENCER or FAVORITES.

Using the analyzer

You can show realtime analysis of the synthesizer's audio output on the display by pressing the ANALYZER button.

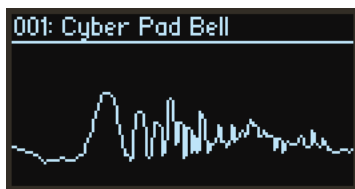

This button switches between a spectrum analyzer, oscilloscope, and the previously displayed page.

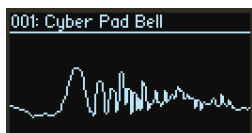

Spectrum analyzer



Oscilloscope



Previously displayed page (Home page)

Performing with the arpeggiator

1. Press the ARPEGGIATOR button. "Arpeggiator Run=On" will appear in the display.



2. The pattern set in the program will be used when you play the keyboard.

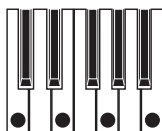

(Arpeggio type: UP)

For more on the patterns, see "PTRN (Arp Pattern)" (→ p.62)

3. When you hold down the ARPEGGIATOR button, "Arpeggiator Run=Latch" will appear in the display and the latch function will be enabled.



The arpeggiator will keep playing, even if you take your hand off the keyboard. Hold down the ARPEGGIATOR button once more to disable the latch function.

4. Press the ARPEGGIATOR button once more to turn off the arpeggiator. "Arpeggiator Run=Off" will appear on the display.



Changing the arpeggiator tempo

To change the tempo, press the TAP TEMPO button several times in rhythm, to match the tempo you want to set.

You can also set a tempo value with the “TEMPO” (A knob) parameter on the SEQ page.

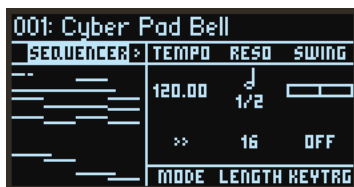

SEQUENCER	TEMPO	RESO	SWING
	120.00	1/2	
	>>	16	OFF
MODE	LENGTH	KEYTRG	

Changing the arpeggio pattern

1. Press the MODE/ARP button while holding down the SHIFT button, and select the ARP page.



ARPEGGIATOR	RUN	PTRN
	OFF	MANUAL ---
	1/8	1
RESO	GATE	OCT

2. Select an arpeggio pattern by changing the “PTRN” (Pattern) parameter with the B knob.



ARPEGGIATOR	RUN	PTRN
	OFF	UP ---
	1/8	1
RESO	GATE	OCT

3. Editing the programs

Editing with the OPERATOR MIXER

In the OPERATOR MIXER section, you can use the RATIO OP 1–6 knobs to edit the pitch (RATIO) parameters for each Operator, and the LEVEL OP 1–6 sliders to edit the output levels.

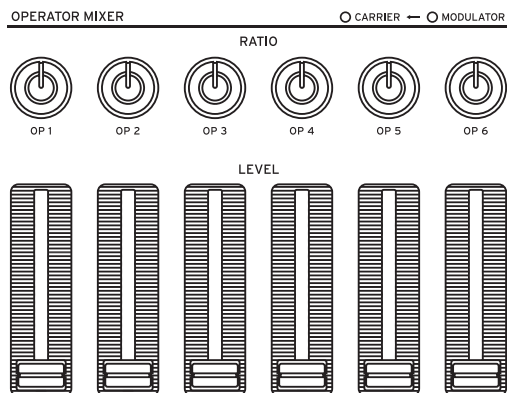

1. Turn the PROGRAM knob to select a program to edit.
2. Move the RATIO OP 1–6 knobs and the LEVEL OP 1–6 sliders of the OPERATOR MIXER.

The effect will change depending on whether the Operator you are editing is a carrier (the RATIO knob LED will light up red) or a modulator (the RATIO knob LED will light up blue).

RATIO knob: Changes the pitch of each Operator. Mainly the pitch changes for carriers, and the brightness of the sound or the position of harmonics changes for the modulators. Raising the pitch of a modulator will emphasize the sparkling harmonics that are characteristic of FM tone generators.

LEVEL slider: Change the output level of each Operator. The volume changes for carriers, and the brightness of the sound or the strength of the harmonics changes for the modulators. When the carrier is in FM mode and the output level of the modulator is brought way up, you can get a heavily distorted sound that's something like a distorted guitar.

Tip: On sounds that use user algorithms, a single Operator may act as both a carrier and a modulator. If this is the case, the LED on the RATIO knob will light up purple.

Note: The effects of V.PATCH (→p.71) and MOTION SEQ (→p.32) can still be heard if the LEVEL slider is set to "0".

Easy program editing

You can edit the main parameters besides those of the Operators in the HOME/ALGO page.

1. Press the  (ALGO) button to display the HOME/ALGO page.
2. Use the DATA ENTRY A–F knobs to change the values for the parameters shown on the display.

ALGO: Select the algorithm that determines the structure for Operators 1–6 from the presets and user algorithm.

ATK: Sets the attack time (how quickly the note starts) for all Operators.

DECAY: Sets the decay/release time (how quickly the note fades out) for all Operators.

FX1–3: Although the way this works depends on the effect type that is set, this mainly changes the depth of the effect.

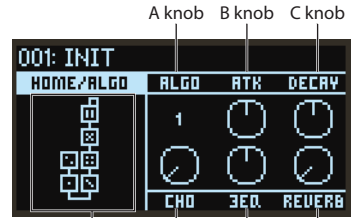

Currently selected algorithm

Randomized editing

This sets the current program's parameters in the selected scope to random values. Use this to find new inspiration when you are creating sounds.

1. Press the  button to display the Randomize page.

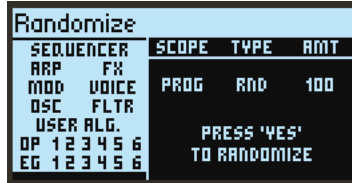

2. Select the scope of parameters to randomize.

Change the “SCOPE” parameter with the DATA ENTRY A knob. “PROGRAM” is selected by default, and all parameters of the program will be set randomly.

Set how the randomization will be done with the “TYPE” parameter.

RND: Changes the selected range of parameters by randomly creating values for each.

SHFFL: Randomly shuffles (exchanges) the values of the selected range of parameters.

NOISE: Adds a random noise value to the selected range of parameters.

Use “AMT” to adjust the randomization strength.

3. Press the YES button to show a confirmation message.

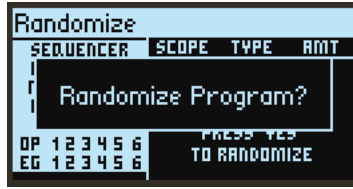

4. Press the YES button again to randomize.

Detailed editing

You can make detailed edits as follows.

1. Press the desired PAGE SELECT button between the MODE and EFFECT buttons to display the corresponding page. To display one of the secondary pages as shown below the buttons, hold the SHIFT button down and select the desired page.

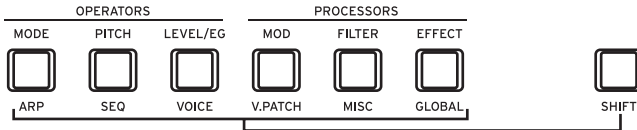

2. Sometimes the left side of the screen will indicate that multiple subpages are available. You can use the PAGE < and > buttons to cycle through them.
3. You can edit the parameters for each Operator on the MODE, PITCH and LEVEL pages. Use the OP SELECT + and – buttons to select the Operator to edit.

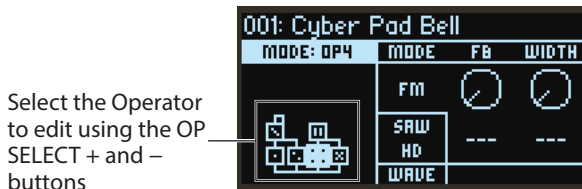

4. Use the DATA ENTRY A-F knobs to change the parameters.

Each page's editable parameters are shown below:

MODE: Change the Operator mode and output waveforms for OP 1–6.

PITCH: Change the pitch of OP 1–6, as well as the pitch modulation from the LFO/EG.

LEVEL/EG: Set the output levels, EG and key tracking for OP 1–6.

MOD: Configure LFO 1–3 and EG 1–3.

FILTER: Set the overall filter used for OP 1–6.

EFFECT: Used for selecting effect types or making detailed edits to the effects.

ARP: Configure the arpeggiator.

SEQ: Used for setting how the sequencer operates, and for making detailed edits to the sequence data.

VOICE: Set whether a sound plays in mono, poly or unison mode.

V.PATCH: Specify the destination and depth of the effect produced by the LFO, EG and other modulation sources.

MISC: Used for changing other program parameters. You can copy Operators on the OP UTIL page.

GLOBAL: Used for configuring the overall instrument. The settings you make in this mode are not saved to a program, but instead apply to all programs. Any changes you make will be saved automatically.

Tip: For details on each parameter, see the “Parameter Guide”, and for more information on the effect parameters, see “Effect Parameter List” (→ p.91).

Saving a program

Save any programs to the opsix that you have edited.

Any edits you make will be lost if you turn off the power of the opsix or select a different program before saving the data.

1. Press the WRITE button.

The opsix will enter program save standby mode, and the YES and NO buttons will blink.

2. Change the program name as necessary.

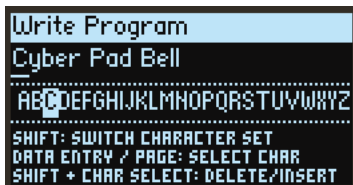

PROGRAM knob: Changes the character at the cursor position.

SHIFT button: Changes the type of character to input.

PAGE < and > buttons: Moves the cursor. Hold down the SHIFT button while pressing the PAGE < button to delete the character at the cursor position. Hold down the SHIFT button while pressing the PAGE > button to insert a blank space at the cursor position.

DATA ENTRY A-F knobs: Turning these knobs left or right is the same as pressing the PAGE < and > buttons in succession.

3. Press the YES button to confirm the program name.

4. Turn the PROGRAM knob to select the program location to which will save your edited sound. Select a different program if you wish to keep the original program.

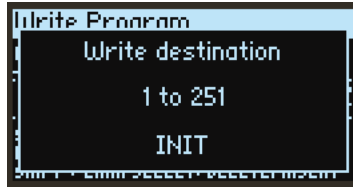

Tip: Press the NO button to cancel.

5. Press the YES button to save the program.
The program will be saved, and the message "Write Completed" will be shown in the display.

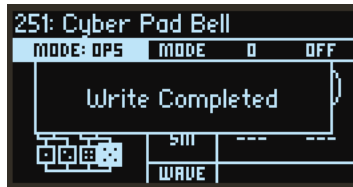

- ⚠ Never turn off the power while a program is being saved. Doing so may corrupt the internal data.

Initializing a program

You can reset all parameters to the INIT program default values.

1. Press the  INITIALIZE button while holding down the SHIFT button. The message “Initialize all param values?” will be displayed, and the YES and NO buttons will blink.
2. Press the YES button to initialize the program. The program will be initialized, and “Program Initialized” will appear in the display.
Tip: Press the NO button to cancel.
3. Save your edits or the entire program as necessary.

Canceling the program edits

You can cancel all edits made to a program and revert the settings of the program to its saved state.

1. Press the WRITE/RECALL button while holding down the SHIFT button. “Revert current changes?” will be displayed, and the YES and NO buttons will blink.
2. Press the YES button to cancel your edits. The edits will be canceled, and the message “Program Recalled” will be shown in the display.
Tip: Press the NO button to cancel.

4. Using the step sequencer

The opsix has a polyphonic sequencer that features up to 16 steps. Sequence data for the step sequencer can be saved in each program. In addition to note data, you can also record and play back motion sequences (these are changes made to the sound using the knobs or sliders on the opsix).

How the sequencer works

MIDI signal flow

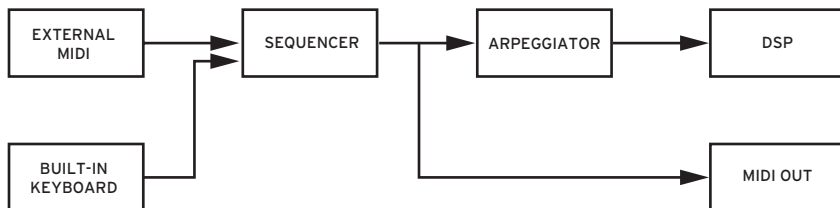

When a MIDI message is received, it will be processed in the sequencer and sent to the next block. For example, MIDI notes received during recording are recorded in the sequencer and passed on to the DSP (sound generator) to output the sound.

As shown in the diagram, MIDI messages are sent only to the modules ahead. For this reason, the arpeggiator can be used to play the sequencer, but the arpeggiator notes cannot be recorded with the sequencer.

Key trigger mode is a feature that resets the sequence each time a key is pressed, and transpose the notes according what key was pressed. Key trigger mode is set when you press the PLAY button while holding down the SHIFT button. When you hold down the SHIFT button and long-press the PLAY button, the latch function is enabled for key trigger mode, and the sequence keeps playing even after you take your hands off the keys.

Notes can be recorded in real time or in step mode. Motions can be recorded in real time, and the values in each motion step can be edited on the SEQUENCER page.

Note sequencer

The note sequencer features 16 steps. Up to six notes (from C-1 to G9) can be recorded in a single step, and the parameters of each note can be adjusted. When the “SWING” effect is off, all step lengths will be the same. Use “RESO” to set the length of a step respective to the tempo.

Motion sequencer

The motion sequencer features 16 steps. The motions for up to six parameters can be recorded and played back. This motion data is recorded in “lanes.” The opsix motion sequencer basically works like the automation feature found on DAWs. The length of each step is also the same on the motion sequencer. To assign a parameter to a lane, use a knob or slider in real time to record changes to the parameter, or select “DEST.”

Playback and recording on the step sequencer

Here we will play back the sequence data recorded for each program.

1. Press the PLAY button.

The sequence data recorded for the currently selected program will play.

2. Press the REC button when you want to record what you play on the keyboard.

The REC button will light up, and all notes that you play afterwards will be recorded as sequence data. Press the REC button again to finish recording.

3. To stop sequence data playback, press the PLAY button again.

⚠ Any data you record will be lost if you turn off the power on the opsix or select a different program before saving the data. See “Saving a program”, p.27.

Step recording

1. Press the SEQUENCER/FAVORITES button to select SEQUENCER.

2. Select a program, and then press the REC button.

The STEP 1 button will blink.



3. Use the STEP 1–16 buttons to select the steps to input.

The STEP buttons that you select will blink.

4. Press one or more keys on the keyboard at the same time to record one or more notes at the current step.

Press one of the STEP 1–16 buttons while holding down a key to record a tie. The tie will connect the note to the step you pressed.

5. When the set number of steps have finished recording, step recording will automatically end (the REC button will go dark).

Press the REC button during recording to stop recording midway.

6. After you have finished recording, save the program.

If you select another program before saving your edited program, the sequence data in the newly selected program will be recalled, and the sequence data you recorded will be lost.

⚠ Saving a program will overwrite the sequence data at that program location.

Tip: When step recording begins, the display will switch to the SEQ NOTE page. The parameters for each step can also be edited in the SEQ NOTE page during step recording.

Recording motions to the motion sequencer with the knobs and sliders

Motion sequencing lets you record changes to the sounds made as a result of operating the knobs and sliders, and then recreates those motions during playback.

Up to six motions using the knobs and sliders (motion sequences) can be recorded on the opsix.

Tip: The knobs and sliders that can be used to record to the motion sequencer are as follows.
DATA ENTRY A–F knobs, RATIO OP 1–6 knobs, LEVEL OP 1–6 sliders, PITCH wheel, MODULATION wheel

1. Press the PLAY button to play the step sequencer.

2. Press the REC button.

Real-time recording will begin.

3. Move the knobs and sliders.

You can record up to six motion sequences for the knobs and sliders.

Note: When you try to record the seventh motion sequence of changes with the knobs and sliders, the message “Motion Full” will be shown on the display. Delete the motion sequences you don’t need in order to record new motions. For details, refer to the CLEAR function on “SEQ UTIL (Sequencer Utility)” (→ p.67).

Note: When you record the motion sequences of knobs and sliders that you have already recorded, the data previously recorded will be overwritten.

4. After the set number of steps have finished recording, the motion sequence will automatically finish recording as well.

Follow steps 1 and on to record motion sequences for other knobs and switches.

The number of steps is set for each program. You can change the number of steps using the “LENGTH” function on the SEQUENCER page “LENGTH” (→ p.64).

Editing sequence data

Erasing step information

The note information recorded in the step sequencer will be erased.

1. Hold down the CLEAR button and press the STEP button to erase.

2. Release the CLEAR button.

The step information you selected in step 1 will be erased.

Copying step information

1. Hold down the DUP. button and press the step from which you wish to copy (copy source).

To copy a single step, press only the step you wish to copy.

To copy a range of steps, hold down the beginning step, and then press the ending step.

2. While holding down the DUP. button, press the step which you wish to copy to (copy destination; multiple destinations are OK).

3. Release the DUP. button.

The step information you selected in step 1 will be copied to the step(s) you selected in step 2.

Selecting steps to be muted

You can mute the steps you don't want to hear during playback (when the REC button is dark) or when the SEQUENCER page is not displayed. Press the buttons from STEP 1–16 you wish to mute to turn them off. Although the notes of steps that are turned off will not play back, the motion sequencer will play back, and the sequence length will not change.

Tip: If you press the STEP 1–16 buttons while the SEQUENCER page is displayed, the buttons will function as step selectors.

• Step jump

While holding down the SHIFT button, press a STEP button to make the sequence jump to that step. This will make the sequence shorter.

Editing note information for a step

If you press the STEP 1–16 buttons while the REC button is lit or while the SEQUENCER page is displayed, the step corresponding to the button you pressed will be selected, and the SEQ NOTE page will display. See “SEQ NOTE (Sequencer Note)” on page 65.

Tip: Each time you press a STEP button you selected while holding down the SHIFT button, the step's “GATE” value increases by 25%.

Use the steps below to edit the note number or velocity value for each note.

1. Hold down the SHIFT button and press the PITCH/SEQ button.
2. Press the PAGE < and > buttons to display the SEQ NOTE page.

STEP	SEQ NOTE	LANE	NOTE	START
STEP 1	2:B4	1	E5	[Knob]
	3:A4	4:E4		[Knob]
	5:F3	6:---		[Knob]

ACTIVE VEL GATE

3. Press one of the STEP 1–16 buttons to select the step to edit.

The STEP button that you selected will blink.

4. Use the DATA ENTRY A knob to select the note you want to edit.

The selected note is shown in highlighted text on the left side of the display.

5. Use the DATA ENTRY B–F knobs to change the parameters.

Tip: “ACTIVE” is set for each step, and cannot be changed for each note. When you want to delete only a certain note, hold down the SHIFT button and turn the DATA ENTRY B knob to set the “NOTE” to “---”.

Detailed editing with the motion sequencer

Use the steps below to edit each step of the motion sequences.

1. Hold down the SHIFT button and press the PITCH/SEQ button.
2. Press the PAGE < and > buttons to display the MOTION page.

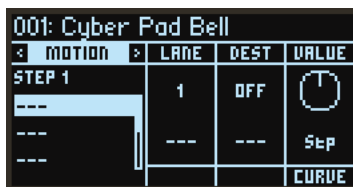

< MOTION >	LANE	DEST	VALUE
STEP 1	1	OFF	⌚
---	---	---	Step
---			CURVE

3. Use the DATA ENTRY A knob to select the lane you wish to edit.
The selected lane is shown in highlighted text on the left side of the display.
4. Press one of the STEP 1–16 buttons to select the step to edit.
The STEP button that you selected will blink.
5. Use the DATA ENTRY B–E knobs to change the parameters.

Parameter Guide

List of parameters

Page Group	Page Name	Knob	Display	Full name	Range	→			
HOME/ALGO	HOME/ALGO	A	ALGO	Algorithm	1–40, User	p.42			
		B	ATK	Attack	–100.0 – +100.0 [%]	p.42			
		C	DECAY	Decay/Release	–100.0 – +100.0 [%]	p.42			
		D	FX1	(1st parameter of FX1)		p.42			
		E	FX2	(1st parameter of FX2)					
		F	FX3	(1st parameter of FX3)					
MODE	MODE	A	MODE	Operator Mode	FM, Ring Mod., Filter, Filter FM, Wave Folder, Effect, Bypass, Mute	p.43			
		D	WAVE	Wave	*“Waveform List”	p.43			
		FM	B	FB	Feedback	0–100 [%]	p.43		
			C	WIDTH	Wave Width	Off, 1–99 [%]	p.43		
			Ring Mod.	B	DEPTH	Ring Depth	0–100 [%]	p.44	
		C		SHAPE	Shape	0–100 [%]	p.44		
		Filter/FilterFM	B	TYPE	Filter Type	LPF, HPF, BPF, BRF, MG LPF12, MG LPF24, MG HPF12, MG HPF24, MG BPF6, MG BPF12, MS-20 LPF, MS-20 HPF	p.44		
			E	CUTOFF	Cutoff	–50.0 – +50.0 [semi]	p.44		
			F	RESO	Resonance	0–100 [%]	p.44		
		Filter	C	OSC MIX	OSC Mix Level	0–100 [%]	p.44		
		Wave Folder	B	GAIN	Gain	0–100 [%]	p.45		
			C	OSC MIX	OSC Mix Level	0–100 [%]	p.45		
			E	BIAS	Bias	–100 – +100 [%]	p.45		
		EFFECT	EFFECT	B	FX	Effect Type	PEAK EQ, SHELV EQ, PHASER, SHORT DELAY, COMB, DIST, DRIVE, DEC, WAVESHAPER, PUNCH	p.46	
				C	OSC MIX	OSC Mix Level	0–100 [%]	p.46	
				PEAK EQ	E	FREQ	Frequency	–50.0–+50.0 [semi]	p.46
					F	GAIN	Gain	–18.0–18.0 [dB]	p.46
				SHELV EQ	E	LOW	Low Gain	–18.0–18.0 [dB]	p.46
					F	HIGH	High Gain	–18.0–18.0 [dB]	p.46
				PHASER	E	FREQ	Frequency	–50.0–+50.0 [semi]	p.47
					F	FB	Feedback	–100–+100 [%]	p.47
				SHORT DELAY	E	TIME	Time	1–300msec	p.47
					F	FB	Feedback	0–100 [%]	p.47
				COMB	E	FREQ	Frequency	–50.0–+50.0 [semi]	p.47
					F	FB	Feedback	–100–+100 [%]	p.47
				DIST	E	DIST	Distortion	0–100 [%]	p.47
					F	LOW	Low Gain	–18.0–18.0 [dB]	p.47
DRIVE	E			DRIVE	Drive	0–100 [%]	p.47		
	F			LOW	Low Gain	–18.0–18.0 [dB]	p.48		

Page Group	Page Name	Knob	Display	Full name	Range	→	
MODE	EFFECT	DEC	E	FREQ	Frequency	2.00–256.00	p.48
			F	BIT	Bit	2.00–24.00	p.48
		WAVESHAPER	E	TYPE	Type	waveshaper type list	p.49
			F	DAMP	High Damp	0–100 [%]	p.49
		PUNCH	E	PUNCH	Punch	0–100 [%]	p.49
			F	HIGH	High Gain	–18.0–18.0 [dB]	p.49
PITCH	PITCH	A	FREQ	Frequency Mode	FIXED, RATIO	p.50	
			C	TRANS	Transpose	–12 – +12 [semi]	p.50
		RATIO	D	COARSE	Coarse Ratio	1/128–32	p.50
			E	FINE	Fine Ratio	0.50–2.00	p.51
			F	DETUNE	Detune	–50.0 – +50.0 [cents]	p.51
			FIXED	D	x100	Fixed Frequency	0.01–9999.99 [Hz]
		E		x1	Fixed Frequency	0.01–9999.99 [Hz]	
		F		x0.01	Fixed Frequency	0.01–9999.99 [Hz]	
	P MOD	A	EG1	EG1 Int	–144.00 – +144.00 [semi]	p.51	
			B	LFO1	LFO1 Int	–144.00 – +144.00 [semi]	p.51
			C	VEL	Velocity Sens	0–100 [%]	p.51
			D	CTRL	EG1 Ctrl Src	**Control Source List*	p.51
E			CTRL	LFO1 Ctrl Src	**Control Source List*	p.51	
F			DEST	Velocity Mod. Dest.	Fine, Coarse	p.51	
LEVEL/EG	EG	A	ATK	Attack Time	0 [msec] – 90.000 [sec]	p.52	
		B	DECAY	Decay Time	0 [msec] – 90.000 [sec]	p.55	
		C	REL	Release Time	0 [msec] – 90.000 [sec]	p.52	
		D	LEVEL	OP Level	0–100 [%]	p.52	
		E	SUS	Sustain Level	0–100	p.52	
		F	CURVE	Curve	0(LIN), 1–9, 10(EXP)	p.52	
	KTRK	A	LOW	Low Slope	–100 – +100 [%]	p.53	
		B	CENTER	Center Key	A0–C9	p.53	
		C	HIGH	High Slope	–100 – +100 [%]	p.53	
		D	L CRV	Low Curve	LIN, EXP	p.53	
		F	H CRV	High Curve	LIN, EXP	p.53	
	LMOD	B	LFO1	LFO1 Int	–100 – +100 [%]	p.54	
		C	VEL	Velocity Sens	0–100 [%]	p.54	
		E	CTRL	LFO1 Ctrl Src	**Control Source List*	p.54	

Page Group	Page Name	Knob	Display	Full name	Range	→
MOD	EG1 PITCH	A	ATK	Attack Time	0 [msec] – 90.000 [sec]	p.55
		B	DECAY	Decay Time	0 [msec] – 90.000 [sec]	p.55
		C	REL	Release Time	0 [msec] – 90.000 [sec]	p.55
		E	SUS	Sustain Level	0–100	p.55
		F	CURVE	Curve	0(LIN), 1–9, 10(EXP)	p.55
	EG2 FLTR	A	ATK	Attack Time	0 [msec] – 90.000 [sec]	p.55
		B	DECAY	Decay Time	0 [msec] – 90.000 [sec]	p.55
		C	REL	Release Time	0 [msec] – 90.000 [sec]	p.55
		E	SUS	Sustain Level	0–100	p.55
		F	CURVE	Curve	0(LIN), 1–9, 10(EXP)	p.55
	EG3	A	ATK	Attack Time	0 [msec] – 90.000 [sec]	p.55
		B	DECAY	Decay Time	0 [msec] – 90.000 [sec]	p.55
		C	REL	Release Time	0 [msec] – 90.000 [sec]	p.55
		E	SUS	Sustain Level	0–100	p.55
		F	CURVE	Curve	0(LIN), 1–9, 10(EXP)	p.55
	LFO1 OP	A	WAVE	Wave	*“LFO Wave List”	p.55
		B	SPEED	Speed	0.01–100.00[Hz], 1/48–4/1	p.56
		C	KSYNC	Key Sync	Off, Common, Voice	p.56
		D	PHASE	Phase	Random, –180 – +180	p.57
		E	TEMPO	Tempo Sync	Off, On	p.57
		F	FADE	Fade	0 [msec] – 9.900 [sec]	p.57
	LFO2 FLTR	A	WAVE	Wave	*“LFO Wave List”	p.55
		B	SPEED	Speed	0.01–100.00[Hz], 1/48–4/1	p.56
		C	KSYNC	Key Sync	Off, Common, Voice	p.56
		D	PHASE	Phase	Random, –180 – +180	p.57
		E	TEMPO	Tempo Sync	Off, On	p.57
		F	FADE	Fade	0 [msec] – 9.900 [sec]	p.57
	LFO3	A	WAVE	Wave	*“LFO Wave List”	p.55
		B	SPEED	Speed	0.01–100.00[Hz], 1/48–4/1	p.56
		C	KSYNC	Key Sync	Off, Common, Voice	p.56
D		PHASE	Phase	Random, –180 – +180	p.57	
E		TEMPO	Tempo Sync	Off, On	p.57	
F		FADE	Fade	0 [msec] – 9.900 [sec]	p.57	

Page Group	Page Name	Knob	Display	Full name	Range	→	
FILTER	FILTER	A	TYPE	Filter Type	LPF 12, LPF 24, LPF MS-20, LPF POLY6, HPF 12, HPF 24, HPF MS-20, BPF 6, BPF 12, BRF 6, BRF 12	p.58	
		D	ENABLE	Enable	Off, On	p.58	
		B	CUTOFF	Cutoff	(TYPE = MS-20, Poly6) 12.98Hz – +21.10kHz (Others) 6.489Hz–23.68kHz	p.58	
		E	RESO	Resonance	0.00–100.00[%]	p.59	
		C	EG2	EG2 Int	–142.00 – +142.00	p.59	
		F	CTRL	EG2 Ctrl Src	**Control Source List*	p.59	
	FLTR MOD	A	LOW	KeyTrk Low Slope	–Inf – +Inf	p.60	
		D	CENTER	KeyTrk Center Key	C-1–G9	p.60	
		B	HIGH	KeyTrk High Slope	–Inf – +Inf	p.60	
		C	LFO2	LFO2 Int	–142.00 – +142.00	p.60	
		F	CTRL	LFO2 Ctrl Src	**Control Source List*	p.60	
		EFFECT	FX 1...3	A	FX	Effect Type	**Effect Parameter List*
	D			ENABLE	Enable	Off, On	p.61
	B			FX EDIT 1	---	**Effect Parameter List*	p.61
C	FX EDIT 2			---	**Effect Parameter List*		
E	FX EDIT 3			---	**Effect Parameter List*		
F	FX EDIT 4			---	**Effect Parameter List*		
ARP	ARPEGGIATOR	A	RUN	Arpeggiator Run	Off, On, Latch	p.62	
		B	PTRN	Arp Pattern	Manual, Up, Down, Alt1, Alt2, Random, Trigger	p.62	
		---	---	---	---	---	
		D	RESO	Resolution	1/32triplet – 1/4	p.63	
		E	GATE	Gate Time	0–100[%]	p.63	
		F	OCT	Octave	1–4[oct]	p.63	
SEQ	SEQUENCER	A	TEMPO	Tempo	40.00–300.00 [bpm]	p.64	
		B	RESO	Step Resolution	1/64–4/1	p.64	
		C	SWING	Swing	–100 – +100 [%]	p.64	
		D	MODE	Step Mode	Forward, Backward, Bounce, Center, Even/Odd, Random	p.64	
		E	LENGTH	Length	1–16	p.64	
		F	ACTIVE	Active Sequencer	BOTH, NOTE, MTN	p.65	
	SEQ NOTE	A	LANE	Lane	1–6	p.65	
		B	NOTE	Lane Note	---, C-1–G9	p.65	
		C	START	Start Offset	0–100[%]	p.65	
		D	ACTIVE	Active	Off, On	p.65	
		E	VEL	Velocity	1–127	p.65	
		F	GATE	Gate Time	0–100[%], Tie	p.65	
	MOTION	A	LANE	Lane	1–6	p.66	
		B	DEST	Dest Scope	OFF, PROG, OP1-6, EG1-3, LFO1-3, FILTER, FX1-3, ARP, SEQ, ALG R1-6, MIDI	p.66	
		C	VALUE	Value	0–100 [%]	p.66	
		D	SYNC	Motion Key Sync	Trigger, Legato, Free	p.66	
		E	DEST	Destination	**Motion Destination List*	p.66	
		F	CURVE	Curve	Step, Exp, Lin, Log	p.67	

Page Group	Page Name	Knob	Display	Full name	Range	→		
SEQ	SEQ UTIL	A	TARGET	Target	NOTE, MTN LANE1-6	p.67		
	TARGET = NOTE	B	FUNC	Function	TRANS, VEL, NUDGE, COPY, INVERT	p.67		
		TRANS	C	VALUE	Value	-12~+12	p.67	
			D	START	Start step	1~16		
			E	END	End step	1~16		
			F	DEST	Destination	1~16		
		VEL	C	VALUE	Value	TYPE=ADD: -127~127, TYPE=SET: 1~127 TYPE=SCALE: 1~200 [%]	p.67	
			D	START	Start step	1~16		
			E	END	End step	1~16		
			F	TYPE	Type	ADD, SET, SCALE		
		NUDGE	C	VALUE	Value	-15~+15	p.67	
			F	DEST	Destination	ALL, NOTE, MOTION		
		COPY	C	REPEAT	Repeat	1~16	p.67	
			D	START	Start step	1~16		
			E	END	End step	1~16		
			F	DEST	Destination	1~16		
	INVERT	C	VALUE	Value	FULL, REL	p.67		
		D	START	Start step	1~16			
		E	END	End step	1~16			
	TARGET = MTN LANE1-6	CLEAR	B	FUNC	Function	CLEAR, DUP, COPY VALUE, COPY CURVE, SET VALUE, SET CURVE, ASSIGN RAMP, ASSIGN SAW, ASSIGN TRI, ASSIGN TRI+, ASSIGN SINE, ASSIGN SQR, AS-SIGN RAND	p.67	
			---	CLEAR	Clear lane	---	p.68	
			DUP	C	REPEAT	Repeat	1~16	p.68
				D	START	Start step	1~16	
				E	END	End step	1~16	
				F	DEST	Destination	1~16	
			COPY VALUE	C	REPEAT	Repeat	1~16	p.68
				D	START	Start step	1~16	
				E	END	End step	1~16	
			COPY CURVE	C	REPEAT	Repeat	1~16	p.68
				D	START	Start step	1~16	
				E	END	End step	1~16	
				F	DEST	Destination	1~16	
			SET VALUE	C	VALUE	Value	0.00~100.00	p.68
				D	START	Start step	1~16	
		E		END	End step	1~16		
		SET CURVE	C	VALUE	Value	STEP, EXP, LIN, LOG	p.68	
			D	START	Start step	1~16		
			E	END	End step	1~16		
		ASSIGN RAMP, ASSIGN SAW, ASSIGN TRI, ASSIGN TRI+, ASSIGN SINE, ASSIGN SQR, ASSIGN RAND	C	SCALE	Scale	-100.00~100.00	p.68	
	D		START	Start step	1~16			
E	END		End step	1~16				
F	OFFSET		Offset	-100.00 - 100.00				

Page Group	Page Name	Knob	Display	Full name	Range	→	
VOICE	VOICE	A	ASSIGN	Voice Assign	Poly, Mono, Mono Legato	p.69	
		B	GLIDE	Glide Mode	Off, On, Legato	p.69	
		C	TIME	Glide Time	0[msec]–50.000[sec]	p.69	
		D	UNISON	Unison Voices	Off, 2–8	p.69	
		E	DETUNE	Unison Detune	0–200[cents]	p.69	
		F	SPREAD	Unison Spread	0–100[%]	p.70	
V.PATCH	V.PATCH 1...12	A	SRC	Source Scope	**“Virtual Patch Source List”	p.71	
		D	SRC	Source			
		B	INT	Mod Int	Depends on destination	p.71	
		E	CTRL	Mod Ctrl Src	**“Control Source List”	p.71	
		C	DEST	Dest Scope	**“Virtual Patch Source List”	p.71	
		F	DEST	Destination	**“Virtual Patch Destination List”		
MISC	PROG PITCH	A	TRANS	Transpose	–12 – +12 [semi]	p.72	
		B	BEND	Pitch Bend Up	–60 – +60 [semi]	p.72	
		C	LFO1	LFO1 Int	–144.00 – +144.00[semi]	p.72	
		D	OCT	Octave	–2 – +2 [oct]	p.72	
		E	---	Pitch Bend Down	–60 – +60 [semi]	p.72	
		F	CTRL	LFO1 Ctrl Src	**“Control Source List”	p.72	
	PROG MISC	A	LEVEL	Program Level	–Inf – +6.0 [dB]	p.73	
		B	ALG FB	Algorithm FB	0–100 [%]	p.73	
		C	PHASE	OSC Phase	Sync, Free, Random	p.73	
		D	LOFI	LoFi	Off, On	p.73	
	USER ALG	FM MATRIX	B-F	x->y	OPx -> OPy	0–100 [%]	p.74
			A	SELF	OPx Self Feedback	0–100 [%]	p.74
		DIRECT OUT	A-F	OPx	OPx Direct Out	Off, On	p.74
	OP UTIL		A	FUNC	Function	COPY OP, COPY EG, COPY KTRK	p.75
			B	FROM	From	1–6	p.75
C			TO	To	1–6	p.75	

Page Group	Page Name	Knob	Display	Full name	Range	→	
GLOBAL	TUNE	---	---	Master Tune	-50 – +50 [ct]	p.76	
		---	---	Transpose	-12 – +12	p.76	
	MIDI	---	---	Global Channel	1–16	p.76	
		---	---	Local Control	Off, On	p.77	
		---	---	Clock	Off, Intern, Extern, Auto	p.77	
		---	---	Convert Position	Pre, Post	p.77	
		---	---	Rx Transport	Off, On	p.78	
		---	---	Rx Prog Chg	Off, On	p.78	
		---	---	Rx CC	Off, On	p.78	
		---	---	Rx Pitch Bend	Off, On	p.78	
		---	---	Tx Transport	Off, On	p.78	
		---	---	Tx Prog Chg	Off, On	p.78	
		---	---	Tx CC	Off, On	p.78	
		---	---	Tx Pitch Bend	Off, On	p.78	
		---	---	Aftertouch Src	Off, Ch, Poly, Both	p.78	
	CTRL	---	---	Velocity Curve	1–9	p.79	
		---	---	Aftertouch Curve	1-5, 24stp, 12stp, Rnd	p.79	
		---	---	Prog Chg Lock	Off, Shift, Home	p.80	
		---	---	Knob Mode	Scale, Jump	p.80	
		---	---	SST Hold Time	0.0–60.0 [s]	p.81	
		---	---	Note Trigger Vel*	1–127	p.81	
	SEQ	---	---	Trigger Quantize	Off, 1, 2, 4	p.81	
		---	---	Record Quantize	Off, Start, All	p.81	
		---	---	Metronome	Off, On	p.81	
		---	---	Metronome Level	0–10	p.81	
		---	---	High Click	Off, On	p.81	
	SYS	---	---	Key Trig Velocity	Off, On	p.81	
		---	---	Auto Power Off	Off, 4H	p.82	
		---	---	Screen Bright	0–10	p.82	
		---	---	LED Bright	0–10	p.82	
		---	---	System ID	1–254	p.82	
			---	---	USB Network	RNDIS, NCM	p.82

*: opsix module only

HOME/ALGO

HOME/ALGO (Home/Algorithm)



ALGO (Algorithm)

Selects the algorithm.

The user algorithms can be edited on the USER ALG (User Algorithm) page. (See “Algorithm List”, p.83)

ATK (Attack)

Sets the attack time (how quickly the note starts) for all Operators.

DECAY (Decay/Release)

Sets the decay/release time (how quickly the note fades out) for all Operators.

FX1, 2, 3

These adjust the most important parameters of each effect. Although the way this works depends on the effect type that is set, this mainly changes the depth of the effect. Edit the detailed settings for each effect with the EFFECT page group. (See “EFFECT”, p.61)

OPERATORS: MODE

MODE: OP1...6 (Operator Mode)

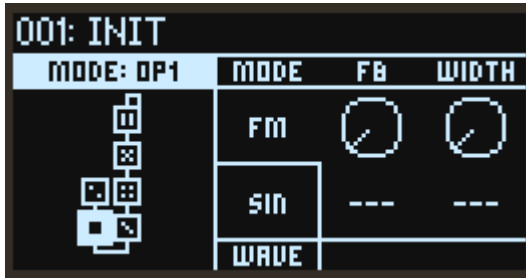

MODE

Selects the Operator mode. (See "Operator modes", p.7)

WAVE

This selects the waveform of the oscillator. (See "Waveform List", p.84)

When "MODE" is set to FM (Frequency Modulation)

The pitch of an oscillator can be changed using the input signal from the modulator.

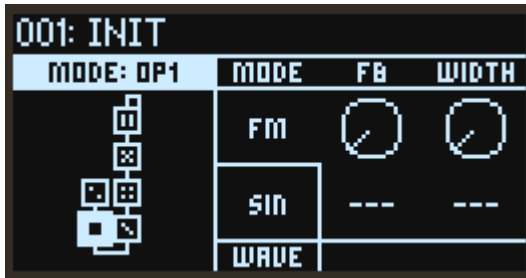

FB (Feedback)

Adjusts the amount of self-feedback from the Operator. When "WAVE" is set to "SIN", the sound will become brighter the closer that the feedback value gets to 75%, sounding more like a sawtooth wave. When the feedback value exceeds 75%, the sound will become more like complex noise as the value gets larger.

WIDTH (Wave Width)

This sets the width of the waveform that was configured using the "WAVE" parameter. You can control the value using V.Patch to get distinctive sounds like those used in dance music.



When “MODE” is set to RING (Ring Modulation)

This uses AM (amplitude modulation) to multiply the input signal from the modulator with the oscillator.

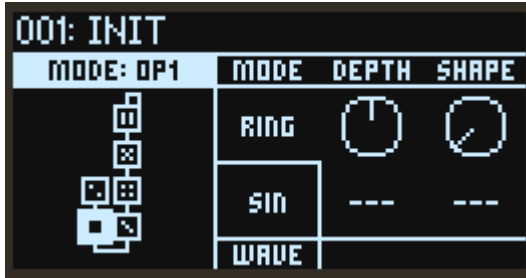

DEPTH (Ring Depth)

Sets the balance between the ring modulator and oscillator signals. A setting of 100% outputs only the ring modulator signal, and a setting of 0% outputs only the oscillator signal.

SHAPE

This is used to rectify the input signal from the modulator. A setting of 50% rectifies the waveform halfway, and a setting of 100% produces a fully rectified waveform. The higher the value, the brighter the tone will sound.

When “MODE” is set to FLTR (Filter)

Filters the input signal to cut out a specified tonal range. You can also mix in the oscillator sound for output. The cutoff frequency works in conjunction with the oscillator pitch.

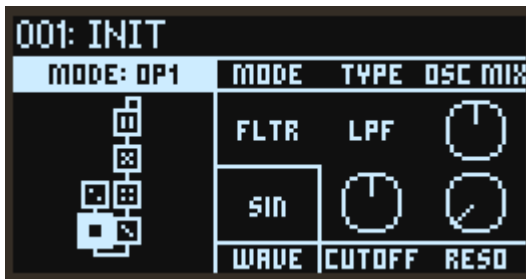

TYPE (Filter Type)

Sets the type of filter used in the Operator.

OSCMIX (OSC Mix Level)

Sets the oscillator level inputted into the filter.

CUTOFF (Cutoff)

Although the filter cutoff frequency works in conjunction with the oscillator pitch, you can use this parameter to add an offset. This is set in semitones.

RESO (Resonance)

Emphasizes the frequencies around the cutoff frequency.

When “MODE” is set to FLTR FM (Filter FM)

In Filter FM, the oscillator signal is used as audio input for the filter. The cutoff frequency is modulated using the input signals from the modulator(s). Depending on the cutoff and filter type settings, this may not have any effect, as the sound outputted from the oscillator may not pass through the filter.

The variations in sound are easier to understand if you set the WAVE parameter to SAW and then change the filter type.

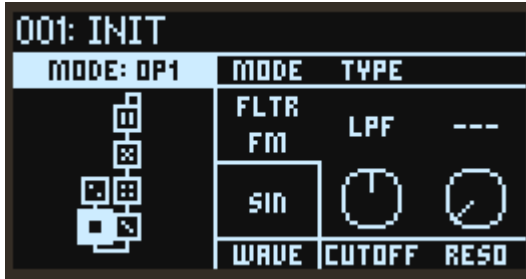

TYPE (Filter Type)

Sets the type of filter used in the Operator.

CUTOFF (Cutoff)

Although the filter cutoff frequency changes with the modulator's input signal, the center frequency changes along with the oscillator pitch, so you can use this parameter to add an offset. This is set in semitones.

RESO (Resonance)

Emphasizes the frequencies around the cutoff frequency.

When “MODE” is set to WAVE FLDR (Wave Folder)

This “folds” the waveform to create a powerful distortion effect.

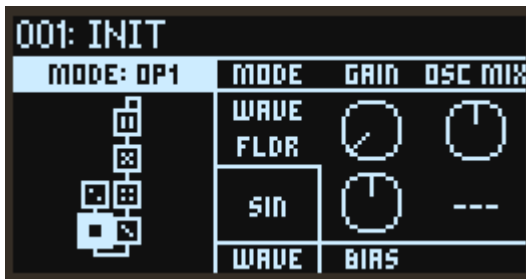

GAIN

Adjusts the strength of the Wave Folder effect. Increasing this value will increase the number of times that the waveform is folded.

OSC MIX (OSC Mix Level)

Sets the oscillator level inputted into the Wave Folder.

BIAS

Applies a DC offset to the input signal to change the harmonics.

When MODE is "EFFECT"

In this mode, the operator functions as an effect like delay, comb filter or distortion. The signal from the oscillator and the input signal from the modulator are inputted into the effect.

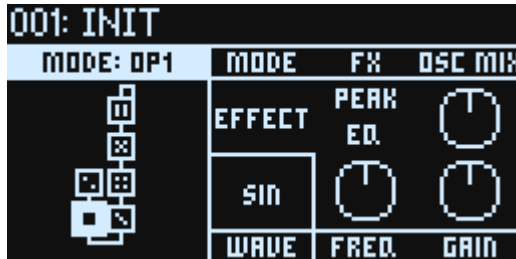

FX (Effect Type)

Sets the type of effect used in the operator.

OSC MIX (OSC Mix Level)

Sets the oscillator level inputted into the effect.

The effect parameters for the E and F knobs differ depending on the effect type.

PEAK EQ (Peaking EQ)

Increases or decreases the level of frequencies within a specific range.

FREQ (Frequency)

Adjusts the center frequency that's increased or decreased. This effect works in conjunction with the oscillator pitch.

GAIN

Increases or decreases the level of center frequencies.

SHELV EQ (Shelving EQ)

This is a shelving-type equalizer. This equalizer boosts or cuts the low- and high-end frequencies.

LOW (Low Gain)

Adjusts the low-end frequency level.

HIGH (High Gain)

Adjusts the high-end frequency level.

PHASER

Alters the phase of the sound to create a swelling effect.

FREQ (Frequency)

Adjusts the frequency at which the effect is applied. This effect works in conjunction with the oscillator pitch.

TIP: If you don't want the frequency to be linked with the pitch, set "FREQ" in "PITCH OP1..6" (p.50) to "FIXED". This sets the frequency at a fixed frequency, regardless of the note number.

FB (Feedback)

Adjusts the amount of feedback.

SHORT DELAY

This effect adds a time delay to the sound.

TIME

Sets the delay time.

FB (Feedback)

Adjusts the amount of feedback.

COMB (Comb Filter)

This is a continuous bandpass and band cut filter, which adds a unique character to the sound.

FREQ (Frequency)

Adjusts the frequency at which the effect is applied. This effect works in conjunction with the oscillator pitch.

TIP: If you don't want the frequency to be linked with the pitch, set "FREQ" in "PITCH OP1..6" (p.50) to "FIXED". This sets the frequency at a fixed frequency, regardless of the note number.

FB (Feedback)

Adjusts the amount of feedback.

DIST (Distortion)

A distortion effect that heavily distorts the sound.

DIST (Distortion)

Adjusts the amount of distortion by adjusting the input level of the distortion circuit.

LOW (Low Gain)

Adjusts the low-frequency region.

DRIVE

A drive effect that adds a heavier distorted feel. Effective for bass guitar and kick drum sounds.

DRIVE

Applies drive to the input signal, which works as a booster to create natural distortion.

LOW (Low Gain)

Adjusts the low-frequency region.

DEC (Decimator)

Creates a cheap and rough sampled effect by lowering the sampling frequency and bit rate.

FREQ (Frequency)

Adjusts the sampling frequency. Lower values give a more lo-fi sound. This effect works in conjunction with the oscillator pitch.

TIP: If you don't want the frequency to be linked with the pitch, set "FREQ" in "PITCH OPI..6" (p.50) to "FIXED". This sets the frequency at a fixed frequency, regardless of the note number.

BIT

Adjusts the bit length. Lower values give a more lo-fi sound.

WAVESHAPER

Recreates the waveshaping method of creating sounds that was used on Korg's "01/W" music workstation, released in 1991.

This effect runs the input sound through a waveshaping table to alter the waveform.

Use the modulator level or OSC MIX to adjust the depth of the waveshaper effect.

TYPE

Selects the waveshaping table type.

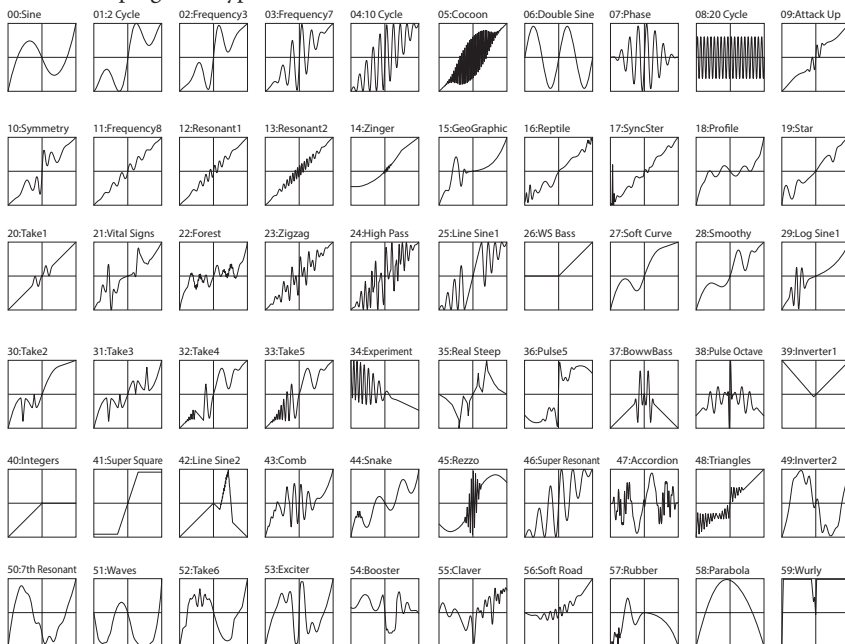

DAMP (High Damp)

Adjusts the high-frequency region. The higher the setting, the more the high-frequency components are cut off.

PUNCH

This sets an effect that emphasizes the attack volume of the input signal.

PUNCH

Adjusts the amount of emphasis.

HIGH (High Gain)

Adjusts the high-frequency region.

OPERATORS: PITCH

PITCH: OP1...6 (Operator Pitch)

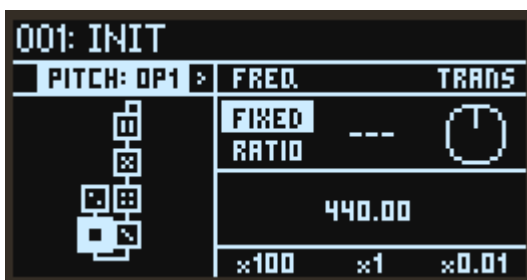

FREQ (Frequency Mode)

Use this to select how the oscillator pitch will be set.

FIXED: With this setting, the oscillator pitch will stay at the same frequency regardless of the note number.

RATIO: With this setting, the frequency of the note number will be multiplied with the ratios set in COARSE (Coarse Ratio) and FINE (Fine Ratio) to set the oscillator pitch.

TRANS (Transpose)

Shifts the oscillator pitch in semitones over a range of ± 1 octave. This setting is enabled only when FREQ (Frequency Mode) is set to "RATIO".

When "FREQ" is FIXED

x100, x1, x0.01

This sets the oscillator frequency over a range of 0.01 to 9999.99 Hz.

When "FREQ" is RATIO



COARSE (Coarse Ratio)

This is used for coarse adjustments of the oscillator pitch. When this setting is "1", the frequency is the same as the note number. When this setting is less than "1", the pitch will shift down in units of octaves. When this setting is more than "1", the pitch will shift up in integer units according to the frequency of the note number.

FINE (Fine Ratio)

Fine-tunes the oscillator pitch. The oscillator frequency is equal to the COARSE (Coarse Ratio), FINE (Fine Ratio) and note number frequency values, all multiplied together.

DETUNE

Detunes the pitch of the oscillator in one-cent steps.

P MOD: OP1...6 (Operator Pitch Modulation)



EG1 (EG1 Int)

Sets the effect of the EG1 applied to the pitch, in semitone steps.

LFO1 (LFO1 Int)

Sets how much the LFO1 will affect the pitch, in semitone steps.

VEL (Velocity Sens)

Sets how much the velocity will affect the pitch.

CTRL (EG1 Ctrl Src)

Selects the modulation source that controls the EG1 Int. The value selected here is multiplied with EG1 (EG1 Int) to determine the amount of pitch modulation. (See “Control Source List”, p.85)

CTRL (LFO1 Ctrl Src)

Selects the modulation source that controls the LFO1 Int. The value selected here is multiplied with LFO1 (LFO1 Int) to determine the amount of pitch modulation. (See “Control Source List”, p.85)

DEST (Velocity Mod. Dest.)

Sets which parameter will be affected by the effect of the velocity on the pitch. This is enabled only when FREQ (Frequency Mode) is set to “RATIO”.

Fine: The effect will be applied to FINE (Fine Ratio). The pitch will be changed continuously by changes in velocity.

Coarse: The effect will be applied to COARSE (Coarse Ratio). Changes to the pitch will be made in stages, with the ratio between the note number and pitch remaining as integers. Using this on Operators that are modulators lets you change the harmonics without muddying the sound.

OPERATORS: LEVEL/EG

EG: OP1...6 (Operator Level/EG)

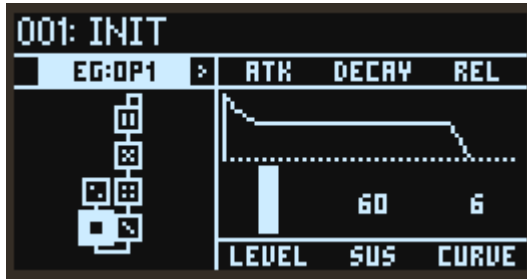

ATK (Attack Time)

Specifies the time from note-on until the maximum level is reached.

DECAY (Decay Time)

This sets how long it takes to settle from the peak to the Sustain level.

REL (Release Time)

This sets how long it takes the envelope to fall to 0 after releasing a note.

LEVEL (OP Level)

Sets the output level of the Operator. This is the same parameter controlled by the OPERATOR MIXER slider.

SUS (Sustain Level)

This sets the level at the end of the Decay time.

When the sustain level is reached, this level is maintained until note off.

CURVE

This sets the decay and release curves.



Curve=0 (LIN)

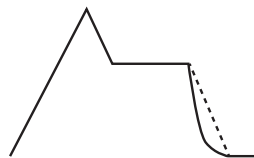

Curve=10 (EXP)

KTRK: OP1...6 (Operator Level Key Track)

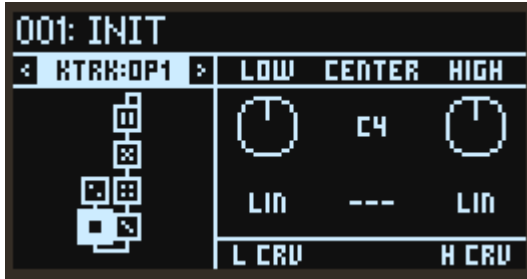

CENTER (Center Key)

This sets the note on the keyboard that is used as a reference for keyboard tracking. The depth of the effect will change according to how far the note you play is from the CENTER (Center Key).

LOW (Low Slope)

Sets the depth of keyboard tracking for notes that are lower than the CENTER (Center Key). When this is set to a positive value, the lower the note is from the CENTER, the greater the Operator's output level will be. When this is set to a negative value, lower notes will produce correspondingly lower output levels.

HIGH (High Slope)

Sets the depth of keyboard tracking for notes that are higher than the CENTER (Center Key). When this is set to a positive value, the higher the note is from the CENTER, the greater the Operator's output level will be. When this is set to a negative value, the higher notes will produce correspondingly lower output levels.

L CRV (Low Curve)

This sets how the effect will change as you play lower notes in relation to the CENTER (Center Key). Setting this to "LIN" will make the effect progressively stronger at a fixed ratio. Setting this to "EXP" will make the effect gradually deeper around the CENTER (Center Key), but the effect will become exponentially stronger for notes played further away from the CENTER (Center Key).

H CRV (High Curve)

This sets how the effect will change as you play higher notes in relation to the CENTER (Center Key). Setting this to "LIN" will make the effect progressively stronger at a fixed ratio. Setting this to "EXP" will make the effect gradually deeper around the CENTER (Center Key), but the effect will become exponentially stronger for notes played further away from the CENTER (Center Key).

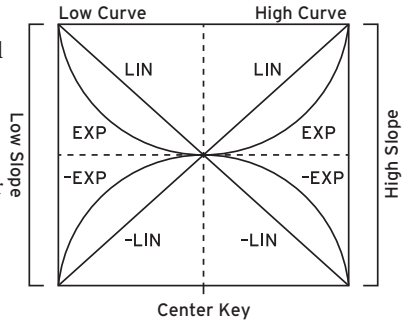

L MOD: OP1...6 (Operator Level Modulation)

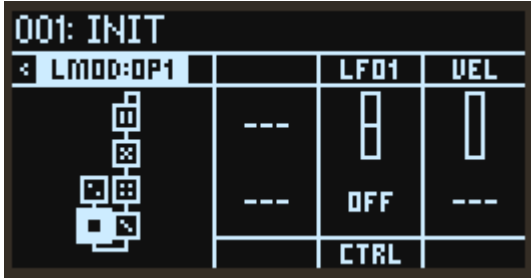

LMOD:OP1	LFO1	VEL
---	▮	▮
---	OFF	---
	CTRL	

LFO1 (LFO1 Int)

This sets how the effect applied to the Operator's output level will change with the LFO1.

VEL (Velocity Sens)

This sets how the effect applied to the Operator's output level will change with the velocity.

CTRL (LFO1 Ctrl Src)

Selects the modulation source that controls the LFO1 Int. The value selected here is multiplied with LFO1 (LFO1 Int) to determine the amount of output level modulation. ("Control Source List" on page 85)

MOD

EG1 PITCH, EG2 FLTR (Filter), EG3 (Assignable)

The opsix features three EGs in addition to the EGs that control the levels of each Operator. By default, EG1 is connected to the Operator pitch and EG2 is connected to the filter. EG3 is not connected to anything, but can be connected with V.Patch (p.71).

ATK (Attack Time)

DECAY (Decay Time)

REL (Release Time)

SUS LV (Sustain Level)

CURVE

See “EG: OP1...6 (Operator Level/EG)”, p.52.

LFO1 OP (Operators), LFO2 FLTR (Filter), LFO3 (Assignable)

The opsix features three LFOs. By default, LFO1 is connected to the Operator pitch and level, and LFO2 is connected to the filter. LFO3 is not connected to anything, but can be connected with V.Patch (p.71).

The screenshot shows a patch editor interface for '001: INIT'. It features a table with columns for 'LFO1 OP', 'WAVE', 'SPEED', and 'KSYNC'. The 'LFO1 OP' column lists 'EG1 PITCH', 'EG2 FLTR', 'EG3', and 'LFO1 OP'. The 'WAVE' column shows 'TRI' and '0'. The 'SPEED' column shows 'SYNC' and 'OFF'. The 'KSYNC' column shows 'CMA' and a clock icon. Below the table, there are labels for 'PHASE', 'TEMPO', and 'FADE'.

< LFO1 OP >	WAVE	SPEED	KSYNC
EG1 PITCH	TRI	[Clock Icon]	CMA
EG2 FLTR			
EG3	0	SYNC	[Clock Icon]
[LFO1 OP]		OFF	
LFO2 FLTR			
LFO3	PHASE	TEMPO	FADE

WAVE

This selects the LFO waveform.

• **LFO Wave List**

TRI (Triangle)



SAW DOWN (Saw Down)



SAW UP (Saw Up)



SQR (Square)



SIN (Sine)



S/H (Sample&Hold)



GTR (Guitar)



X.TRI (Exp. Triangle)



X.SAW DOWN (Exp. Saw Down)



X.SAW UP (Exp. Saw Up)



TRI4 (Step4 Triangle)



TRI6 (Step6 Triangle)



SAW4 DOWN (Step4 Saw Down)



SAW6 DOWN (Step6 Saw Down)



S.RND TIME (StepRnd: Time)



S.RND LVTIME (StepRnd: Lvl&Time)



RND LEVEL (Random: Level)



RND TIME (Random:Time)



RND LVTIME (Random:Lvl&Time)



TRI+ (Triangle +)

SAW DOWN+ (Saw Down +)

SAW UP+ (Saw Up +)

SQR+ (Square +)

Take a look at the comments below on some of the waveforms.

GTR (Guitar): This is for guitar vibrato. The value is positive only, and when it is set using pitch, only a pitch bend up effect will result.

S/H (Sample&Hold): This is a typical sample/hold waveform, on which the level changes at random in fixed intervals.

S.RND LVTIME (StepRnd: Lvl&Time): Randomly changes the level and timing.

S.RND TIME (StepRnd: Time): Generates a pulse wave at a random timing.

RND LEVEL (Random: Level), RND TIME (Random: Time), RND LVTIME (Random: Lvl&Time): Different from step-based changes, these are smoothed versions of S/H, S.RND TIME and S.RND LVTIME that create non-linear changes. Use these for gradual random changes.

Triangle + ... Square +: This outputs only positive values, as opposed to the waveforms from Triangle to Square that output values from -1 to +1. This is useful when you want a cyclical pitch-up or pitch-down effect.

SPEED

When TEMPO (Tempo Sync) is on, this sets the base LFO speed as a note length.

When TEMPO (Tempo Sync) is off, this sets the LFO speed in Hz.

KSYNC (Key Sync)

Specifies how the LFO will be applied to a voice when note-on occurs.

Off: The LFO phase will not be reset when note-on occurs. It will only be reset when selecting a program or starting step sequencer playback.

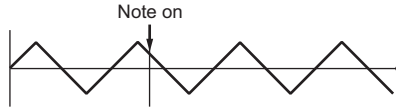

CMN (Common): The phase of the LFO will be reset by the first note-on that occurs from a condition of no keys being held; it will not be reset for subsequently played voices.

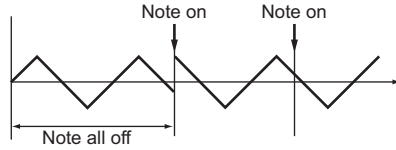

VOICE: The LFO phase will be reset with each note-on, and modulation will be applied in differing phases to each voice.

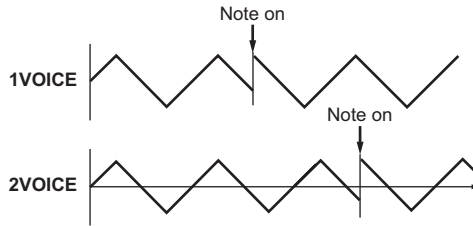

PHASE

This sets the phase when the LFO is reset. When this is set to RND, the LFO will start with a different phase for each note-on message.

TEMPO (Tempo Sync)

On: The note length will be set using SPEED. The LFO frequency will synchronize to the system tempo, as it is controlled by this speed.

Off: The LFO speed is controlled by the SPEED parameter, in Hz.

FADE

The LFO can fade in gradually, instead of starting immediately at full strength. This sets the time from note-on until the LFO reaches maximum amplitude.

Note: This will have no effect when “KSYNC” is off.

FILTER

FILTER

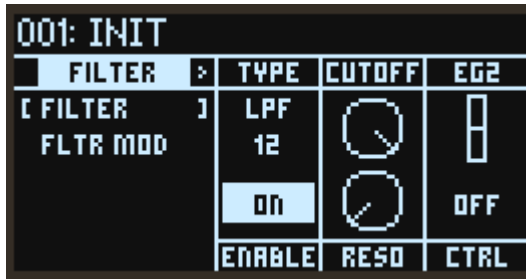

TYPE (Filter Type)

This is used to select the filter type. The resulting sound will be different depending on the selected filter type. For LPF, HPF, BPF and BRF, the digits at the end of the filter name (6, 12, 24) indicates the filter characteristics (dB/oct). The larger the value, the more abruptly that the filter will cut off the sound at the cutoff frequency.

LPF 12, LPF 24: This cuts out the parts of the sound which are higher than the cutoff frequency. Low Pass is the most common type of filter, and is used to make bright timbres sound darker.

HPF12, HPF24: This cuts out the parts of the sound which are lower than the cutoff frequency. These filters are effective when the low end is too strong, or when you want a thinner sound.

BPF6, BPF12: This cuts out all parts of the sound, both highs and lows, except for the region around the cutoff frequency. Because of this, the sound can change dramatically depending on the cutoff setting and the Operator's sound settings. With low resonance settings, you can use the Band Pass filter to create telephone or vintage phonograph sounds. With higher resonance settings, it can create buzzy or nasal timbres.

BRF6, BRF12: These are also called "notch filters" because of the dip in the midrange levels. Only the parts of the sound at and directly around the cutoff frequency are cut off. Try modulating the cutoff with an LFO to create phaser-like effects. This filter type—also called a notch filter—cuts only the parts of the sound directly around the cutoff frequency. Try modulating the cutoff with an LFO to create phaser-like effects.

LPF MS-20, HPF MS-20: Both of these are 12dB/oct filters that can self-oscillate and replicate the distinctive tonal character of the Korg MS-20. If the input level is high, raising Resonance will cause increasing amounts of saturation and overdrive, creating a more aggressive tone.

LPF Poly6: This is a 24dB/oct filter that can self-oscillate, which replicates the powerful yet sweet tonal character of the Korg Polysix.

ENABLE

Switches the filter effect on/off.

CUTOFF

Sets the cutoff frequency of the filter in Hz. As explained above, the cutoff frequency effect will differ depending on the type you select. The range of most filter types is from 6.489 Hz to 23.68 kHz, but the range of the MS-20 LPF/HPF and LPF Poly6 is from 12.98 Hz to +21.10 kHz.

RESO (Resonance)

Resonance emphasizes the frequencies around the cutoff frequency, as shown in the diagram below. This will have no effect with a setting of 0.

At medium settings, the resonance will alter the timbre of the filter, making it sound more nasal, or more extreme.

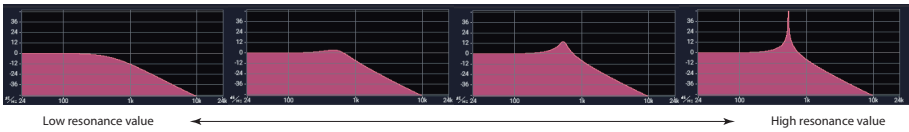

Note: For some filter types, oscillation may occur within the filter when RESO (Resonance) is set to a high value. This may cause the oscillation to continue even after note-off. To avoid this kind of oscillation, use V.Patch to control the resonance value using an EG, or use a filter on the Operator Mode side.

EG2 (EG2 Int)

This sets the amount that the EG2 modulates the cutoff parameter.

CTRL (EG2 Ctrl Src)

Selects the modulation source that controls the EG2 Int. The source selected here is multiplied with EG2 Int to determine the amount of cutoff modulation. (See “Control Source List”, p.85)

FLTR MOD (Filter Modulation)

< FLTR MOD	LOW	HIGH	LFO2
FILTER [FLTR MOD]	 C4	 ---	 OFF
	CENTER		CTRL

LOW (KeyTrk Low Slope)

Sets the depth of key tracking for notes that are lower than the Center Key. When this is set to a positive value, the cutoff frequency correspondingly increases for lower notes. When this is set to a negative value, the cutoff frequency correspondingly decreases for lower notes. A setting of “-1.00” will make the cutoff frequency change with the same slope as the key pressed on the keyboard.

HIGH (KeyTrk High Slope)

Sets the depth of key tracking for notes that are higher than the Center Key. When this is set to a positive value, the cutoff frequency correspondingly increases for higher notes. When this is set to a negative value, the cutoff frequency correspondingly decreases for higher notes. A setting of “+1.00” will make the cutoff frequency change with the same slope as the key pressed on the keyboard.

CENTER (KeyTrk Center Key)

This sets the note used as a reference for keyboard tracking. The cutoff frequency will change according to the distance between the inputted note and the reference note. When you play the same note as the reference note, the cutoff frequency will be the same as the setting on the Filter page.

LFO2 (LFO2 Int)

This sets the amount that the LFO2 modulates the cutoff parameter.

CTRL (LFO2 Ctrl Src)

Selects the modulation source that controls the LFO2 Int. The source selected here is multiplied with LFO2 Int to determine the amount of cutoff modulation. (See “Control Source List”, p.85)

EFFECT

FX 1, 2, 3 (Effect 1, 2, 3)

The opsix features three multi-effectors. These three effectors are connected in a series.



FX (Effect Type)

Selects the effect type.

ENABLE

Switches the effect on/off. You can listen and compare how the effects sound by switching them on and off.

Effect Parameter 1...4

This configures the parameters of each effect.

For more on the parameters, see “Effect Parameter List”, p.91.

ARP (Arpeggiator)

ARPEGGIATOR



RUN (Arpeggiator Run)

Switches the arpeggiator between on, off and latch.

Off: The arpeggiator will not operate.

On: The arpeggiator will only operate when a note is played.

Latch: The arpeggiator will begin operating when a note is played, and will keep going even after the note is released.

PTRN (Arp Pattern)

This parameter specifies the note pattern of the arpeggiator.

MANUAL: The arpeggio is played in the order that note-on signals held down together are played.

UP: The arpeggio is played from the lower tone (note) to the higher note.



DOWN: The arpeggio is played from the higher tone (note) to the lower note.



ALT1: The arpeggio repeatedly plays up and down. (The highest and lowest notes will be played once.)



ALT2: The arpeggio repeatedly plays up and down. (The highest and lowest notes will be played twice.)

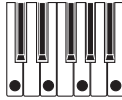

RANDOM: The notes are played randomly.

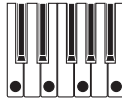

TRIGGER: The notes you hold down will be played simultaneously at the tempo and “RESO” timing.

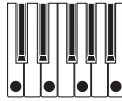

RESO (Resolution)

This controls the speed of the Arpeggiator.

GATE (Gate Time)

This sets the length of the arpeggiated notes, as a percentage of the Resolution.

OCT (Octave)

This controls the range of the arpeggiated notes.

SEQ (Sequencer)

SEQUENCER



TEMPO

Specifies the tempo for the selected program. This setting is applied not only to the sequencer but also to the arpeggiator, LFO and effects that synchronize with the tempo.

RESO (Step Resolution)

Sets the length of a step in relation to the tempo.

SWING

Adjusts the intensity of the swing.

TIP: Setting this to "+33%" gives you nearly a full shuffle timing.

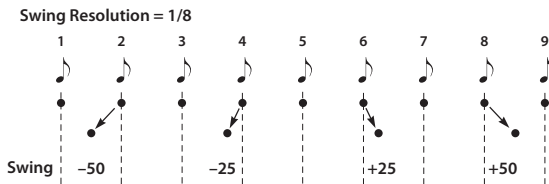

MODE (Step Mode)

Specifies how steps advance during playback.

- >> (**Forward**): Makes the sequencer play back forward.
- << (**Backward**): Makes the sequencer play back in reverse.
- >><< (**Bounce**): Makes the sequencer play back forward, and then in reverse.
- >< (**Center**): Playback will occur in the following order: 1, 16, 2, 15, 3, 14...
- >>>> (**Even/Odd**): The sequencer plays back only odd-numbered or even-numbered steps.
- RND (**Random**): Makes the sequencer play back randomly.

LENGTH

Sets the number of steps used in the sequence.

ACTIVE (Active Sequencer)

This allows you to select which of the sequencers are enabled for playback and recording.

NOTE: Only notes are enabled.

MTN: Only motion sequences are enabled.

BOTH: Both notes and motion sequences are enabled.

Note: When the sequencer is playing, a white LED will indicate which step is currently being played. When “Active Sequencer” is set to BOTH or NOTE, the current step of the note sequencer will be displayed. However, when set to MOTION, the current step of the motion sequencer will be displayed. Please note that, depending on the “Motion Key Sync” setting, these values can differ.

SEQ NOTE (Sequencer Note)



LANE

Up to six notes can be used in one step on the opsix. Select the lane where the note will go, from 1 to 6.

NOTE (Lane Note)

This sets the note number for the selected step and lane.

START (Start Offset)

Sets the timing used to trigger a step, as a percentage of the step length.

Increasing the RESO (Resolution) lets you easily create the timings often used in hip-hop and neo-soul music, as well as sounds like strumming and flams.

ACTIVE

Sets whether this step is triggered or not.

VEL (Velocity)

Sets the velocity of the selected step and lane.

GATE (Gate Time)

Sets the note length of the selected step and lane. When you want to make a note sound for longer than the step length, use a tie to connect the note to the next step.

MOTION

< MOTION >	LANE	DEST	VALUE
STEP 1	1	OFF	⌚
---	TRIG	---	Lin
---	SYNC		CURVE

LANE

The opsix uses six lanes that automatically “play” the parameters (motion sequences). Select a motion sequence lane from 1 to 6.

DEST (Dest Scope, Destination)

This sets the parameters and groups to be changed by the motion sequence. Refer to “Motion Destination List” (→ p.86) for details.

VALUE

This specifies the value of the selected lane and step.

SYNC (Motion Key Sync)

This parameter affects how the motion sequencer behaves in relation to the note sequencer. Please note that this parameter affects all motion lanes.

TRIG (Trigger): When key trigger is active, the motion sequencer will reset to the beginning of the sequence and begin playback whenever a new note is played. If the “Active Sequencer” setting is changed while the sequencer is playing, this setting will sync the motion sequencer to the note sequencer.

LEGATO: When key trigger is active, the motion sequencer will reset to the beginning of the sequence and begin playback the first time the note sequencer is triggered, after which it will continue independently until no notes are being played. If the “Active Sequencer” setting is changed while the sequencer is playing, this setting will sync the motion sequencer to the note sequencer.

FREE: The motion sequencer will run independent of the note sequencer, modulating the destination values for as long as the opsix is running. This is true even if “Active Sequencer” is set to NOTE.

Note: The current step indicated by the upward arrow on this page is displaying information relevant to the motion sequencer. When “Motion Key Sync” is set to LEGATO or FREE, the motion sequencer may be offset from the note sequencer, and as such not align with the LED step indicator when “Active Sequencer” is set to BOTH.

CURVE

Select the curve that connects the values from the selected steps of the currently selected lane to the next step.

You can select “Step” (no curve), “Exponential”, “Linear” or “Logarithmic”. To make smooth changes to the parameters, select either “Exponential”, “Linear” or “Logarithmic”. On the other hand, for parameters like “WAVE” and “PTRN”, select “Step” so that the parameter changes at the beginning of the step in question to produce the desired effect.

SEQ UTIL (Sequencer Utility)

This page offers a number of utility functions for editing and creating sequence data. Select the function to execute, the range and so on, and press the YES button to execute.



SEQ UTIL	TARGET	FUNC	VALUE
	NOTE	TRANS	+12
	1	16	---
	START	END	

TARGET

Select either the note sequence or one of the six motion sequencers as the target for the utility function.

FUNC

Selects the function to execute.

Note Sequence Functions (When “TARGET” is NOTE)

TRANS (Transpose): Transposes the sequence between START and END by the number of semitones set by the VALUE parameter.

VEL (Velocity): Allows you to adjust the velocity of the notes between START and END. The TYPE parameter offers three sub-operations, that will apply the VALUE parameter in different ways. ADD simply adds or subtracts from the existing velocity, SET overwrites the existing velocity, and SCALE multiplies the existing velocity by the VALUE parameter.

NUDGE: Shifts the sequence forward or backwards. The VALUE parameter specifies how many steps the sequence will be shifted by, and the DEST parameter allows you to select the note sequence, motion sequences, or both to be affected by the operation.

COPY: Copies the notes between START to END to the step specified by DEST. The REPEAT parameter allows you to sequentially copy/paste the selected notes multiple times.

INVERT (Invert Pitch): Inverts the note sequence between START and END around the pitch axis. The VALUE parameter specifies whether the inversion is relative to the full range of MIDI notes (FULL) or the range of the note sequence itself (REL). Composers have been known to flip sheet music upside down to get new ideas, so this can be a fun creative tool.

Motion Sequence Functions (When “TARGET” is MTN LANE 1...6)

001: INIT		
SEQ UTIL	TARGET	FUNC
---	MTA	---
---	LANE 1	CLEAR
---	---	---

CLEAR: Deletes the motion sequence for the selected lane. This turns DEST off, deletes the routing, resets the VALUE for each step and changes the CURVE to “LIN”.

DUP: Copies the selected step. Use START and END to select the copy source range, and DEST to select the start of the copy destination. The REPEAT parameter allows you to sequentially copy/paste the selected motion multiple times.

COPY VALUE: Copies the VALUE only for the selected step. Use START and END to select the copy source range, and DEST to select the start of the copy destination. The REPEAT parameter allows you to sequentially copy/paste the selected motion multiple times.

COPY CURVE: Copies the CURVE only for the selected step. Use START and END to select the copy source range, and DEST to select the start of the copy destination. The REPEAT parameter allows you to sequentially copy/paste the selected motion multiple times.

SET VALUE: This sets the values for the range that you selected using START and END to the same VALUE.

SET CURVE: This sets the curve for the range that you selected using START and END to the same CURVE.

ASSIGN RAMP: This changes the VALUE for the range that you selected using START and END and creates a waveform. Use “SCALE” to set the gain and polarity, and “OFFSET” to set the up/down offset.

ASSIGN SAW: This changes the VALUE for the range that you selected using START and END and creates a waveform. Use “SCALE” to set the gain and polarity, and “OFFSET” to set the up/down offset.

ASSIGN TRI: This changes the VALUE for the range that you selected using START and END and creates a waveform. Use “SCALE” to set the gain and polarity, and “OFFSET” to set the up/down offset.

ASSIGN TRI+: This changes the VALUE for the range that you selected using START and END and creates a waveform. Use “SCALE” to set the gain and polarity, and “OFFSET” to set the up/down offset.



ASSIGN SINE: This changes the VALUE for the range that you selected using START and END and creates a waveform. Use “SCALE” to set the gain and polarity, and “OFFSET” to set the up/down offset.

ASSIGN SQR: This changes the VALUE for the range that you selected using START and END and creates a waveform. Use “SCALE” to set the gain and polarity, and “OFFSET” to set the up/down offset.

ASSIGN RAND: This changes the VALUE for the range that you selected using START and END and creates a waveform. Use “SCALE” to set the gain and polarity, and “OFFSET” to set the up/down offset.

VOICE

VOICE (Voice Assign)

001: INIT			
VOICE	ASSIGN	GLIDE	TIME
	POLY	OFF	
	OFF		
UNISON DETUNE SPREAD			

ASSIGN (Voice Assign)

This selects the basic voice allocation mode.

Poly: The Program will play polyphonically, allowing you play chords.

Mono: The Program will play monophonically, producing only one note at a time.

Mono Legato: The Program will play monophonically. The first note in a legato phrase will sound normally; subsequent notes in the phrase will sound smoother (for instance, envelopes will continue instead of restarting).

GLIDE (Glide Mode)

Glide mode makes the pitch change smoothly between different notes.

Off: The glide effect will be disabled, and notes will always play at their correct pitch.

On: The pitch will change smoothly between notes.

Legato: The pitch will change smoothly between notes only when playing legato.

TIME (Glide Time)

Sets the amount of time it takes to move from one pitch to the next.

UNISON (Unison Voices)

Off: Unison is off, and Stereo Spread and Detune do not apply.

2...8: Specifies the number of voices that will sound for each note you play. When this is off, voices will not sound in unison, and "Spread" and "Detune" cannot be applied. You can make up to eight voices play in unison.

DETUNE (Unison Detune)

This controls the chorus feeling for Unison Voice. The pitch width between voices is adjustable in one-cent steps (1/100 of a semitone).

- **Voices = 3, Detune = 24**

Voices	Detune
1	-12
2	0
3	+12

- **Voices = 4, Detune = 24**

Voices	Detune
1	-12
2	-4
3	+4
4	+12

SPREAD (Unison Spread)

SPREAD (Unison Spread) lets you create a wider stereo field when using Unison.

V.PATCH

V.PATCH 1...12 (Virtual Patch 1...12)

001: INIT				SRC	INT	DEST
V.PATCH						
1	2	3	4	OFF	○	OFF
5	6	7	8			
9	10	11	12	---	OFF	---
					CTRL	

SRC (Source Scope), SRC (Source)

Selects the modulation source signal. (See “Virtual Patch Source List”, p.88)

INT (Mod Int)

Specifies the depth of the effect produced by the modulation source.

CTRL (Mod Ctrl Src)

Selects the modulation source that controls Mod Int. The source value selected here is multiplied with Mod Int to determine the depth of the modulation effect. (See “Control Source List”, p.85)

DEST (Dest Scope, Destination)

This sets the parameters and groups to be changed by modulation. (See “Virtual Patch Destination List”, p.89)

MISC

PROG PITCH (Program Pitch)



The screenshot shows a digital display with the following content:

PROG PITCH :	TRANS	BEND	LFO1
[PROG PITCH]	0	+2	
PROG MISC			
USER ALG	0	-2	OFF
OP UTIL			
	OCT		CTRL

TRANS (Transpose)

Adjusts the overall pitch in semitone steps over a range of ± 1 octave for the entire program.

OCT (Octave)

This sets the basic pitch, in octaves. The default is 0.

BEND (Pitch Bend Up)

This sets the maximum amount of pitch bend, in semitones, when you move the wheel above the center point. For normal pitch bend, set this to a positive value.

BEND (Pitch Bend Down)

This sets the maximum amount of pitch bend, in semitones, when you move wheel below the center point. For normal pitch bend, set this to a negative value.

LFO1 (LFO1 Int)

This controls the initial effect of the LFO1 on the pitch, in semitones.

CTRL (LFO1 Ctrl Src)

Selects the modulation source that controls the LFO1 Int. The source value selected here is multiplied with LFO1 Int to determine the depth of the modulation effect. (See “Control Source List”, p.85)

PROG MISC (Program Misc)



LEVEL (Program Level)

Sets the volume for the entire program. The result will be applied to the effect output.

ALG FB (Algorithm FB)

Aside from the user algorithms, feedback algorithms are connected like a feedback loop that sends signals upwards through the algorithm. (ALGO X, X, .. X) This parameter sets the signal level that flows through the feedback loop. The feedback loop is picked up following the LEVEL (Program Level) of the Operator, which lets you use the changes in LEVEL (Program Level) to affect the feedback as well, creating complex effects.

PHASE (OSC Phase)

This sets this oscillator's phase for each note-on as follows.

SYNC: Sets the oscillator phase to "0".

FREE: Sets the value for all oscillators to the same random value.

RANDOM: Sets and changes the value for each oscillator's phase randomly.

LOFI (LoFi)

When this is turned on, the oscillator waveform and level control signals are tuned more roughly, creating a slightly noisy sound that is like an older digital synth.

USER ALG (User Algorithm)

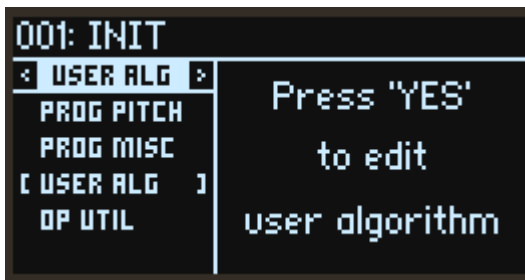

Select this page and press the YES button to edit the user algorithms. Go to a different page to finish editing.

OP UTIL (Operator Utilities)

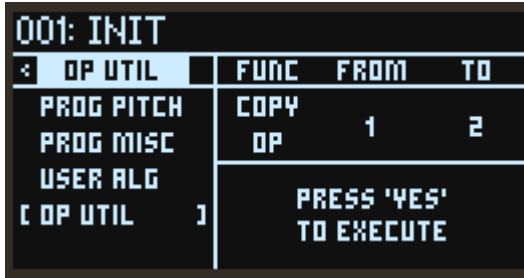

001: INIT			
<	OP UTIL	FUNC	FROM TO
	PROG PITCH	COPY	
	PROG MISC	OP	1 2
	USER ALG		
[OP UTIL]
PRESS 'YES' TO EXECUTE			

This page provides convenient functions for creating sounds, such as copying all of the Operator parameters and so on. Select the function and Operator, and then press the YES button to execute.

FUNC

Selects the function you want to execute.

COPY OP: Copies all of an Operator's parameters.

COPY EG: Copies only the EG parameters.

COPY KTRK: Copies only the key tracking parameters.

FROM

Selects a copy source Operator.

TO

Selects a copy destination Operator.

GLOBAL

This page is used for configuring the overall settings for the opsix. Use the PAGE < and > buttons or DATA ENTRY A–D knobs to change the category. The OP +/- buttons or the DATA ENTRY B/E knobs change the parameter, and the DATA ENTRY C/F knobs change the value.

TUNE

Global Parameters		
Cat.	Param.	Val.
TUNE	Master Tune	Oct
MIDI	Transpose	0
CTRL		
SEQ		

Master Tune

This adjusts the overall tuning for the entire opsix in one-cent units (semitone = 100 cents), over a range of ± 50 cents.

When the value is set to 0 cents, A4 is equal to 440 Hz.

Transpose

Adjusts the overall pitch of notes you play on the keyboard in semitones, over the range of one octave up or down. These settings are applied at the position (Pre or Post) set using “ConvertPosition”.

MIDI

Global Parameters		
Cat.	Param.	Val.
TUNE	Global Channel	1
MIDI	Local Control	On
CTRL	Clock	Off
SEQ	Convert Position	Pre

Global Channel

Specifies the MIDI channel. This MIDI channel will be used for transmitting and receiving note messages, pitch bend and control change messages.

Local Control

Sets the local control setting.

On: Normally, this should be turned “On”. However, if you are using the opsix with an external sequencer or the likes, you will want to set local control to “Off” to eliminate the double-triggering of notes caused by MIDI echo.

Off: The opsix’s keyboard will be internally disconnected from the tone generator. With this setting, the opsix’s tone generator will not sound when you play the opsix’s keyboard.

Clock

Off: The opsix will use the program’s tempo settings. MIDI clock messages will not be transmitted or received.

Intern (Internal): The opsix will use the Performance’s Tempo setting. Use this when playing the opsix by itself, or when you want the opsix to control the tempo of external MIDI devices such as a sequencer or drum machine.

Extern (External): The opsix tempo will synchronize to incoming MIDI Clock messages from either 5-pin MIDI or USB. If MIDI clocks are not being received, tempo-related features will not function.

Auto: This combines the functionality of Internal and External, so that you don’t have to manually switch between the two:

- If MIDI Clocks are not being received, the opsix uses its internal tempo.
- If MIDI Clocks are being received, they control the tempo. If the clocks stop for more than 500 ms, the opsix switches back to internal tempo.

Convert Position

This sets how the velocity curve and transpose settings will work in response to MIDI IN/OUT signals.

⚠ Regardless of the Convert Position, Transpose and Velocity Curve always apply when playing internal sounds directly from the opsix keyboard.

Pre: Applies the velocity curve and transpose settings to the data outputted from the opsix’s keyboard. The data that is affected by the settings (velocity curve and transpose) is the data transmitted from the MIDI OUT when playing the keyboard of the opsix. This has no effect on MIDI data received from MIDI IN.

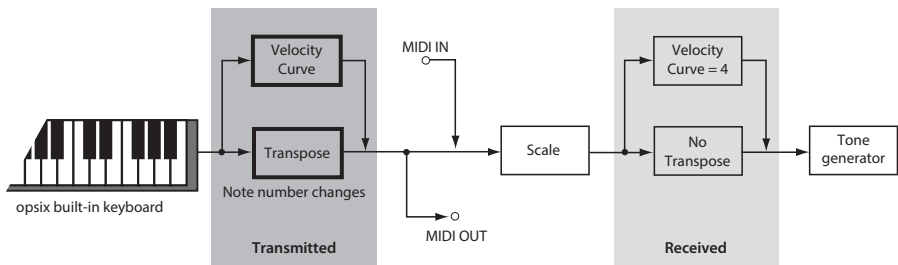

Post: Applies the velocity curve and transpose settings to the data just before it is fed into the sound generator. The data that is affected by the settings (velocity curve and transpose) is the data played with the keyboard of the opsix before it is sent to the sound generator, as well as the data received via MIDI IN. This has no effect on MIDI data transmitted from MIDI OUT when playing the keyboard of the opsix.

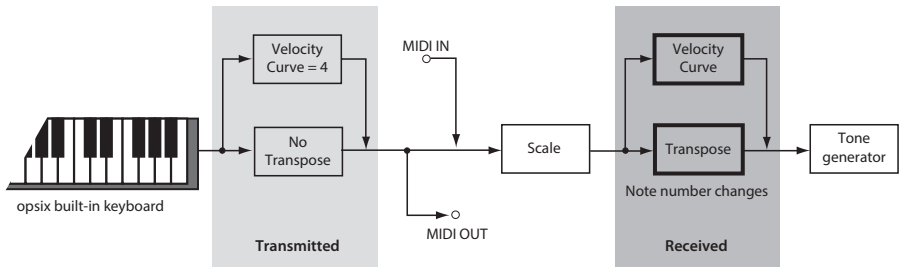

Rx Transport

Sets whether start and stop messages (which are MIDI real-time messages) will be received.

Rx Prog Chg

Selects whether MIDI program change messages will be received.

Rx CC

Selects whether MIDI control change messages will be received.

TIP: CC#1 (Modulation Wheel), CC#64 (Damper) and CC#120 onward cannot be controlled using this setting.

Rx Pitch Bend

Selects whether MIDI pitch bend messages will be received.

Tx Transport

Sets whether start and stop messages (which are MIDI real-time messages) will be transmitted.

Tx Prog Chg

Selects whether MIDI program change messages will be transmitted.

Tx CC

Selects whether MIDI control change messages will be transmitted.

Tx Pitch Bend

Selects whether MIDI pitch bend messages will be transmitted.

Aftertouch Src

If you select "AFTERTOUCH" as a modulation source for an operator, filter, V.Patch and so on, this selects which MIDI message is applied.

Off: The aftertouch effect is disabled.

Ch: Channel pressure is applied. The effect is applied at the same intensity for all note numbers. For the opsix SE, the key aftertouch effect is also applied.

Poly: Polyphonic key pressure is applied. The effect intensity varies according to the note number. For the opsix SE, the key aftertouch effect is not applied.

Both: Both channel and polyphonic key pressure are applied.

CTRL (Controller)

Global Parameters		
Cat.	Param.	Val.
TUNE	Velocity Curve	4
MIDI	Aftertouch Curve	3
CTRL	Prog Chg Lock	Off
SEQ	Knob Mode	Scale

Velocity Curve

This controls how the volume and/or tone responds to variations in keyboard playing dynamics (velocity). Choose the curve that is most appropriate for your playing strength and style. Velocity Curves always work the same way between the built-in keyboard and the synth engine. The way that they relate to MIDI, however, is tied to the Convert Position setting (see below).

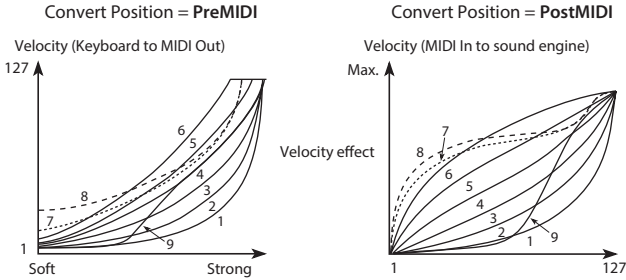

Aftertouch Curve

When playing the keys, you can control how your aftertouch pressure changes the effect. Select the curve that best suits your playing style.

The aftertouch curve always takes effect between the keyboard and the sound generator.

For the opsix SE: The aftertouch curve is always enabled for the keyboard on this unit. For MIDI input, the aftertouch curve is only enabled when Convert Position is set to "Post MIDI".

For input sources aside from the opsix SE: The aftertouch curve is always enabled for external MIDI input.

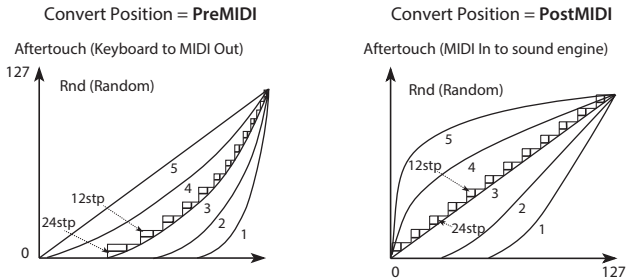

1 (Heavy), 2: This curve produces an effect when you press strongly into the keys.

3 (Normal): This is the typical curve.

4, 5 (Light): These curves let you produce dynamic change without having to press down very hard.

24stp, 12stp: These settings change the dynamics in steps of 24 and 12 respectively, and may be useful when you don't want to use too much memory while recording your aftertouch performance in the sequencer. (Set "Convert Position" to "PreMIDI".) In particular, as curve 7 changes the dynamics in 12 steps, you should set the amount of change to one octave if you're using aftertouch to alter the pitch in halfnote steps.

Rnd: This is a random curve. Use this when you want to create special effects or to use aftertouch for creating irregular modulation.

Prog Chg Lock

Normally, you can always change programs using the PROGRAM knob, but this setting allows you to limit this feature. This prevents you from accidentally changing the program when you are focused on editing or playing a certain sound.

Off: Program changes will always be allowed.

Shift: Program changes will only be allowed when you hold down the SHIFT button and turn the PROGRAM knob.

Home: Program changes will only be allowed on the HOME/ALGO page.

Knob Mode

When you switch to a new program, the parameter values of the front panel knobs will change; but the knobs do not actually move automatically. Knob Mode controls what happens when you move a knob.

Scale: This is the default. The physical position of the knob is mapped to the current parameter value. Moving the knob counter-clockwise goes from the current value to the minimum; moving clockwise goes from the current value to the maximum. If you turn the knob all the way to the left or right, the range is reset.

See the graphic below.

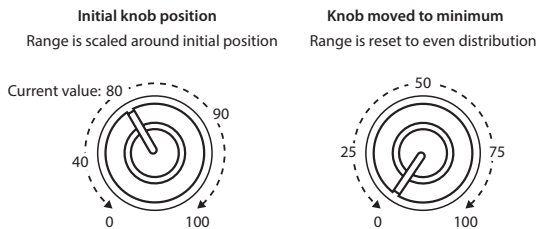

Jump: When a knob is moved, the parameter value instantly changes to match the position of the knob.

SST Hold Time

This controls the duration of Smooth Sound Transitions. It sets how long reverbs, delays, and note releases continue to ring out after a new sound has been selected. The timer starts after all notes from the previous sound are no longer being held down, and the sustain pedal is released.

Note Trigger Vel

opsix module only: Sets the velocity of the note-on events that are transmitted by the note trigger function (→p. 21).

SEQ

Global Parameters		
Cat.	Param.	Val.
TUNE	Trigger Quantize	Off
MIDI	Record Quantize	Start
CTRL	Metronome	On
SEQ	Metronome Level	5

Trigger Quantize

This prevents the sequence from getting out of rhythm by lining up the timing of the sequencer steps (quantizing) when using the step jump or key trigger function. The operation will be immediately reflected when this is OFF, but setting this to 1, 2 or 4 steps will quantize the timing of the step interval you set.

Record Quantize

This automatically corrects the timing of notes that are played during real-time recording.

Off: The note-on and note-off timing will be reflected into the START and GATE parameters as-is.

Start: The note-on timing will always be at the beginning of each step. The note-off timing will be reflected in the GATE parameter.

All: The note-on timing will always be at the beginning of each step. The GATE parameter will be set to 75% or “TIE”, according to the note-off timing.

Metronome

Sets whether the metronome will sound during real-time recording.

Metronome Level

Sets the metronome volume.

High Click

Sets whether the pitch of the first metronome beat will be accented.

Key Trig Velocity

Determines whether the note sequencer responds to the velocity with which a key is played when triggering a sequence. When set to ON, the played velocity will scale the programmed velocity values between 10% and 200% of their original value.

SYS

Global Parameters		
Cat.	Param.	Val.
SYS	Auto Power Off	Off
	Screen Bright	10
	LED Bright	10
	System ID	254

Auto Power Off

By default, to conserve energy, opsix will automatically turn off after about four hours have elapsed without use of the front panel, keyboard, or MIDI input. You can disable this feature, if desired.

- ⚠ When the power turns off, any un-saved edits or settings will be lost. Make sure that you save important settings before this occurs.

Screen Bright

This controls the brightness of the display.

LED Bright

Sets the maximum brightness of the LEDs.

System ID

This number identifies the opsix to computer hosts. If you have multiple opsix, set each to a different number.

USB Network

This sets the communication method (protocol) used when you connect this instrument to your computer with a USB cable.

RNDIS: Uses the RNDIS protocol to communicate with the connected computer. If you're using Windows, use this setting.

NCM: The network control model protocol. If you're using a Mac (macOS 11.0 or later), use this setting.

- ⚠ The changes you make to this parameter's setting are enabled after you restart the opsix.

Algorithm List

1

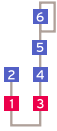

2

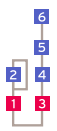

3

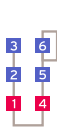

4

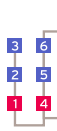

5

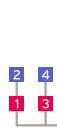

6

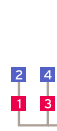

7



8

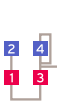

9

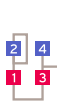

10

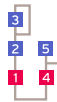

11

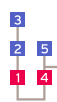

12

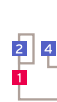

13

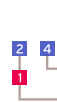

14

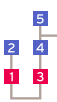

15



16



17

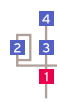

18

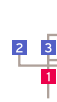

19

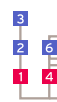

20

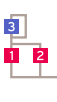

21

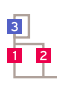

22

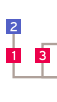

23

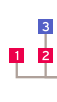

24

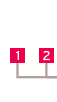

25

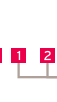

26

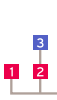

27



28

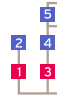

29



30



31



32



33

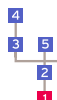

34

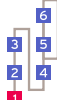

35



36



37

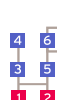

38



39



40



Waveform List

Display	Full name	Notes
SIN	Sine	Generates a sine wave. This is the basic waveform used in FM synthesizers, as it contains a fundamental tone but no overtones.
SIN 12BIT	Sine 12bit	Generates a sine wave with coarse resolution such as that used in old digital synthesizers.
SIN 8BIT	Sine 8bit	Generates a sine wave with even coarser resolution. This is effective for making sounds with noise.
TRI	Triangle	Generates a triangle wave. Unlike the sine wave, this waveform contains harmonics, but also has a rounder feel than the sawtooth or square wave.
SAW	Saw	Generates a sawtooth wave. This waveform is used to create sounds typical of analog synthesizers, such as synth basses and brass.
SAW HD	Saw HD	Generates a sawtooth wave with richer high-end overtones than the normal sawtooth wave, by using a large amount of CPU power.
SQR	Square	Generates a square wave. This waveform is used for electronic and wind instrument sounds.
SQR HD	Square HD	Generates a square wave with richer high-end overtones than the normal square wave, by using a large amount of CPU power.
ADTV SAW3	Additive Saw3	Generates the first three harmonics of a sawtooth wave.
ADTV SQR3	Additive Sqr3	Generates the first three harmonics of a square wave.
ADTV TRI3	Additive Tri3	Generates the first three harmonics of a triangle wave.
ADTV 12345	Additive 12345	Generates an amplitude equal to the first through fifth harmonics. This is like a filtered sawtooth wave.
ADTV 1+2	Additive 1+2	Generates a wave with an amplitude equal to the fundamental tone and second harmonic. This is like the 8' and 4' stops on an organ.
ADTV 1+3	Additive 1+3	Generates an amplitude equal to the fundamental tone and third harmonic. This is like the 8' and +2 2/3' stops on an organ.
ADTV 1+4	Additive 1+4	Generates a wave with an amplitude equal to the fundamental tone and fourth harmonic. This is like the 8' and +2' stops on an organ.
ADTV 1+5	Additive 1+5	Generates an amplitude equal to the fundamental tone and fifth harmonic. This is like the 8' and +1 3/5' stops on an organ.
ADTV 1+6	Additive 1+6	Generates a wave with an amplitude equal to the fundamental tone and sixth harmonic. This is like the 8' and +1 1/3' stops on an organ.
ADTV 1+7	Additive 1+7	Generates an amplitude equal to the fundamental tone and seventh harmonic.
ADTV 1+8	Additive 1+8	Generates a wave with an amplitude equal to the fundamental tone and eighth harmonic. This is like the 8' and +1' stops on an organ.
NOISE S/H	Noise S/H	Generates noise with a musical element, by means of a sample hold circuit.
NOISE WHITE	Noise White	Generates white noise. A certain level of noise is added to the sound throughout the frequency spectrum.
NOISE PINK	Noise Pink	Generates pink noise. Noise is added to the sound in inverse proportion to the frequency.
NOISE BLUE	Noise Blue	Generates blue noise. Noise is added to the sound in proportion to the frequency.

Control Source List

Short name	Full name
MOD WHEEL	Modulation Wheel
PITCH WHEEL	Pitch Wheel
PITCH WHL+	Pitch Wheel +
PITCH WHL-	Pitch Wheel -
PEDAL	Damper Pedal
NOTE	Note Number
VEL	Velocity
EXP VEL	Exp. Velocity
REL VEL	Release Velocity
AFTER TOUCH	Aftertouch*
EG1	EG1 (Pitch)
EG2	EG2 (Filter)
EG3	EG3 (Assignable)
LFO1	LFO1 (Operator)
LFO2	LFO2 (Filter)
LFO3	LFO3 (Assignable)

*: This cannot be input using the keyboard on the opsix. You can control this parameter via MIDI input signals.

Motion Destination List

Scope		Destination		Notes		
Display	Full name	Display	Full name			
OFF	Off	---	---	---		
PROG	Program	PITCH	Pitch	---		
		OCT	Octave	---		
		TRANS	Transpose	---		
		LEVEL	Level	---		
		PAN	Pan	Controls the fixed left-right PAN position.		
		ATK TIME	Attack Time	This is the Attack parameter on the ALGO page. This controls the relative decay and release times for all Operators.		
		DECAY TIME	Decay Time	Controls the relative decay times for all Operators.		
		REL TIME	Release Time	Controls the relative release times for all Operators.		
		SUS LEVEL	Sustain Level	Controls the relative sustain levels for all Operators.		
		DECAY/REL	Decay/Release	This is the Decay/Release parameter on the ALGO page. This controls the relative decay and release times for all Operators.		
		GLIDE MODE	Glide Mode	---		
		GLIDE TIME	Glide Time	---		
		UNISON VOICES	Unison Voices	---		
		UNISON DETUNE	Unison Detune	---		
		UNISON SPREAD	Unison Spread	---		
		TEMPO	Tempo	---		
		ALGO	Algorithm	---		
		ALGO FB	Algorithm FB	---		
		OP1..6	Operator1..6	PITCH	Pitch	---
				COARSE RATIO	Coarse Ratio	---
FINE RATIO	Fine Ratio			---		
DETUNE	Detune			---		
TRANS	Transpose			---		
FIXED FREQ	Fixed Frequency			---		
LEVEL	Level			---		
ATK TIME	Attack Time			---		
DECAY TIME	Decay Time			---		
REL TIME	Release Time			---		
SUS LEVEL	Sustain Level			---		
FM FB	FM Feedback			---		
FM WIDTH	FM Wave Width			---		
RING DEPTH	Ring Mod. Depth			---		
RING SHAPE	Ring Mod. Shape			---		
FILTER CUTOFF	Filter Cutoff			---		
FILTER RESO	Filter Resonance			---		
FILTER OSCMIX	Filter OSC Mix			---		
FOLDER GAIN	Wave Folder Gain			---		
FOLDER BIAS	Wave Folder Bias			---		
FOLDER OSCMIX	WaveFolder OSCMix			---		
EFFECT OSCMIX	Effect OSC Mix			---		
PEQ FREQ	Peak.EQ Frequency			---		
PEQ GAIN	Peak.EQ Gain			---		
S.EQ LOW	Shelv.EQ Low Gain			---		

Scope		Destination		Notes
Display	Full name	Display	Full name	
OP1..6	Operator1..6	S.EQ HIGH	Shelv.EQ High Gain	---
		PHASER FREQ	Phaser Frequency	---
		PHASER FB	Phaser Feedback	---
		S.DLY TIME	S.Delay Time	---
		S.DLY FB	S.Delay Feedback	---
		COMB FREQ	Comb Frequency	---
		COMB FB	Comb Feedback	---
		DIST AMT	Distortion Amount	---
		DIST LOW	Distortion Low Gain	---
		DRIVE AMT	Drive Amount	---
		DRIVE LOW	Drive Low Gain	---
		DEC FREQ	Decimator Freq.	---
		DEC BIT	Decimator Bit	---
		WS DAMP	WS High Damp	---
		PUNCH AMT	Punch Amount	---
		PUNCH HIGH	Punch High Gain	---
		KTRK LOW	Keytrack Low	---
		KTRK HIGH	Keytrack High	---
		LMOD VEL	Level Mod Velocity	---
EG1..3	EG1..3	ATK TIME	Attack Time	---
		DECAY TIME	Decay Time	---
		REL TIME	Release Time	---
		SUS LEVEL	Sustain Level	---
LFO1..3	LFO1..3	WAVE	Wave	---
		SPEED	Speed	---
		SYNC SPEED	Sync Speed	---
		FADE	Fade	---
FILTER	Filter	CUTOFF	Cutoff	---
		RESO	Resonance	---
FX1..3	FX1..3	Effect parameters 1-4		Depends on the effect type.
ARP	Arpeggiator	RUN	Run	---
		PTRN	Pattern	---
		RESO	Resolution	---
		GATE	Gate Time	---
		OCT	Octave	---
SEQ	Sequencer	SWING	Swing	---
ALG R1..6	User alg. row 1..6	x->y	x->y	---
		SELF	Self	---
MIDI	MIDI	PITCH WHEEL	Pitch Wheel	---
		MOD WHEEL	Mod Wheel	---
		AFTER TOUCH	After Touch	---
		CC 2..119	CC 2..119	---

Virtual Patch Source List



Scope		Source		Notes
Display	Full name	Display	Full name	
OFF	Off	---		---
CTRL	Controller	MOD WHEEL	Modulation Wheel	---
		PITCH WHEEL	Pitch Wheel	---
		PITCH WHL+	Pitch Wheel +	This effect will be applied when the PITCH wheel is moved in the + direction (away from you).
		PITCH WHL-	Pitch Wheel -	This effect will be applied when the PITCH wheel is moved in the - direction (towards you).
		PEDAL	Damper Pedal	---
KBD	Keyboard	NOTE	Note Number	The effect will be applied according to the note number. The center note is 60 (C4).
		VEL	Velocity	---
		EXP VEL	Exp. Velocity	The effect will be applied exponentially in relation to the velocity. The effect will not be readily evident at lower velocity values, but will be applied at a steep curve with higher velocity values.
		REL VEL	Release Velocity	The effect will be applied according to release velocity (how quickly you release the key after you play a note).
EG LFO	EG/LFO	EG1	EG1 (Pitch)	---
		EG2	EG2 (Filter)	---
		EG3	EG3 (Assignable)	---
		LFO1	LFO1 (Operator)	---
		LFO2	LFO2 (Filter)	---
		LFO3	LFO3 (Assignable)	---
CC +	CC Unipolar	1..119	CC 1..119 +	When the CC value is "0", the V.Patch effect will also be "0". When the intensity is a positive value, increasing the CC value will result in a positive effect only. (this works the opposite with a negative value).
CC +/-	CC Bipolar	1..119	CC 1..119 +/-	When the CC value is "64", the V.Patch effect will be "0". When the intensity is a positive value, increasing the CC value above 64 will result in a positive effect, and reducing the value will result in a negative effect. (this works the opposite with a negative value).
MIDI	MIDI	AFTER TOUCH	After Touch	---
		POLY AFTER	Poly After Touch	---

Virtual Patch Destination List

Scope		Destination		Notes
Display	Full name	Display	Full name	
OFF	Off	---	---	---
PROG	Program	PITCH	Pitch	---
		OCT	Octave	---
		TRANS	Transpose	---
		LEVEL	Level	---
		PAN	Pan	Controls the left-right position in the stereo field.
		ATK TIME	Attack Time	Controls the relative attack times for all Operators.
		DECAY TIME	Decay Time	Controls the relative decay times for all Operators.
		REL TIME	Release Time	Controls the relative release times for all Operators.
		SUS LEVEL	Sustain Level	Controls the relative sustain levels for all Operators.
		TEMPO	Tempo	---
		ALGO	Algorithm	---
		ALGO FB	Algorithm FB	---
		GLIDE TIME	Glide Time	---
		UNISON VOICES	Unison Voices	---
		UNISON DETUNE	Unison Detune	---
		UNISON SPREAD	Unison Spread	---
OP1..6	Operator 1..6	PITCH	Pitch	---
		COARSE RATIO	Coarse Ratio	---
		OCT	Octave	---
		TRANS	Transpose	---
		LEVEL	Level	---
		ATK TIME	Attack Time	---
		DECAY TIME	Decay Time	---
		REL TIME	Release Time	---
		SUS LEVEL	Sustain Level	---
		FM FB	FM Feedback	---
		FM WIDTH	FM Wave Width	---
		RING DEPTH	Ring Mod. Depth	---
		RING SHAPE	Ring Mod. Shape	---
		FOLDER GAIN	Wave Folder Gain	---
		FOLDER BIAS	Wave Folder Bias	---
		FOLDER OSC MIX	Wave Folder OSC Mix	---
		FILTER CUTOFF	Filter Cutoff	---
		FILTER RESO	Filter Resonance	---
		FILTER OSC MIX	Filter OSC Mix	---
		EFFECT OSC MIX	Effect OSC Mix	---
		PEQ FREQ	Peak.EQ Frequency	---
		PEQ GAIN	Peak.EQ Gain	---
		S.EQ LOW	Shelv.EQ Low Gain	---
		S.EQ HIGH	Shelv.EQ High Gain	---
		PHASER FREQ	Phaser Frequency	---
		PHASER FB	Phaser Feedback	---
		S.DLY TIME	S.Delay Time	---
		S.DLY FB	S.Delay Feedback	---
		COMB FREQ	Comb Frequency	---
		COMB FB	Comb Feedback	---
		DIST AMT	Distortion Amount	---
		DIST LOW	Distortion Low Gain	---

Scope		Destination		Notes
Display	Full name	Display	Full name	
OP1..6	Operator1..6	DRIVE AMT	Drive Amount	---
		DRIVE LOW	Drive Low Gain	---
		DEC FREQ	Decimator Freq.	---
		DEC BIT	Decimator Bit	---
		WS DAMP	WS High Damp	---
		PUNCH AMT	Punch Amount	---
		PUNCH HIGH	Punch High Gain	---
EG1..3	EG1..3	ATK TIME	Attack Time	---
		DECAY TIME	Decay Time	---
		REL TIME	Release Time	---
		SUS LEVEL	Sustain Level	---
LFO1..3	LFO1..3	WAVE	Waveform	---
		SPEED	Speed	---
		PHASE	Phase	---
		FADE	Fade	---
FILTER	Filter	CUTOFF	Cutoff	---
		RESO	Resonance	---
FX1..3	FX1..3	Effect parameters 1-4		Depends on the effect type.
ARP	Arpeggiator	RESO	Resolution	---
		GATE	Gate Time	---
		OCT	Octave	---
SEQ	Sequencer	SWING	Swing	---

Effect Parameter List

Effect name		Knob	Parameter name		Range
Display	Full name		Display	Full name	
CHO	Chorus	B	MIX	Dry:Wet Mix	0–100
		C	DEPTH	Depth	0–100 [%]
		E	SPEED	Speed	0.020–20.000 [Hz]
		F	PHASE	LFO Phase	0.0–100.0 [%]
		Varies the delay time of the input signal to create a thicker or warmer sound. Use the PHASE parameter to shift the left and right LFOs for control of how the sound spreads out.			
U.ENS	Unison Ensemble	B	MIX	Dry:Wet Mix	0–100
		C	DEPTH	Depth	0–100 [%]
		E	RATE	Rate	0–100 [%]
		F	VOICE	Voices	2–8
		Creates a rich, wide sound like multiple oscillators playing in unison. The DEPTH and RATE parameters simulate the detuning of the oscillators, and the VOICE parameter is used to simulate the number of oscillators.			
PHA/PHA 	Phaser/Phaser (BPM)	B	MIX	Dry:Wet Mix	0–100
		C	DEPTH	Depth	0–100 [%]
		E	SPEED	Speed	0.020–20.000 [Hz] / 1/48–4/1
		F	RESO	Resonance	0.0–100.0 [%]
		Alters the phase of the sound to give the sound a swelling effect. This is effective for electric pianos and similar sounds. Use the PHASE parameter to shift the left and right LFOs for control of how the sound spreads out.			
PAN/PAN 	Auto Pan/Auto Pan (BPM)	B	DEPTH	Depth	0–100 [%]
		C	TYPE	Waveform Type	Triangle, Sine, Vintage, Up, Down, Square
		E	SPEED	Speed	0.020–20.000 [Hz] / 1/48–4/1
		F	PHASE	LFO Phase	0.0–100.0 [%]
		This is an auto pan that moves the sound to the left and right. Moving the left and right LFOs gives effects such as both channels crossing past or following each other.			
FLNG/FLN 	Flanger/Flanger (BPM)	B	MIX	Dry:Wet Mix	0–100
		C	DEPTH	Depth	0–100 [%]
		E	SPEED	Speed	0.020–20.000 [Hz] / 1/48–4/1
		F	FDBK	Feedback	–100 – +100 [%]
		An effect that creates a wild swelling sound and a sense of motion in pitch. This is effective for sounds that contain many overtones.			
RTRY	Rotary Speaker	B	BAL	Horn/Rotor Balance	R100:H0–R0:H100 [%]
		C	SPD SW	Speed Switch	Slow, Fast
		E	SPEED	Speed	–100.0 – +100.0 [%]
		F	SPKR	Speaker Type	Natural, Natural + Direct, Resonant, Resonant + Direct, Bright, Bright + Direct, Original CX-3
		An effect that realistically simulates a vintage rotary speaker. By assigning the MODULATION wheel on the V.PATCH page to the SPD SW parameter, you can use the wheel to switch between slow and fast, which is effective for performance.			

Effect name		Knob	Parameter name		Range
Display	Full name		Display	Full name	
A.WAH	Auto Wah	B	MIX	Dry:Wet Mix	0–100
		C	SENS	Envelope Sens	0.0–100.0 [%]
		E	SHAPE	Envelope Shape	–100 – +100 [%]
		F	RESO	Resonance	0–100 [%]
		This effect simulates an auto-wah. The effect sweeps according to changes in input signal strength (the envelope). This sound is often used in funk music for choppy guitar rhythms, clav sounds and so on.			
EXC	Exciter	B	MIX	Dry:Wet Mix	0–100
		C	FREQ	Emphasis Frequency	3000–24000 [Hz]
		E	BLEND	Blend	–100 – +100 [%]
		This effect adds dynamics to the sound and emphasizes its clarity. FREQ controls the frequencies to be emphasized, and BLEND controls the effect depth.			
ENH	Enhancer	B	MIX	Dry:Wet Mix	0–100
		C	DEPTH	Depth	0–100 [%]
		E	DELAY	Delay	0.0–100.0 [%]
		F	SPREAD	Spread	0.0–100.0 [%]
		This effect widens out and adds presence to the sound.			
FLTR	LFO Filter	B	CUTOFF	Cutoff Frequency	0–100 [%]
		C	RESO	Resonance	0–100 [%]
		E	DEPTH	LFO Depth	0–100 [%]
		F	SPEED	LFO Speed	0.020–20.000 [Hz]
		This effect uses an LFO to shift the cutoff frequency of the low-pass filter. Effective for adding a sense of motion to a phrase.			
3EQ	3-Band EQ	B	1 LOW	Band1 Low Gain	–18.0 – +18.0 [dB]
		C	3 HIGH	Band3 High Gain	–18.0 – +18.0 [dB]
		E	2 GAIN	Band2 Mid Gain	–18.0 – +18.0 [dB]
		F	2 FREQ	Band2 Mid Frequency	20–20000 [Hz]
		This is a three-band equalizer. Used for adjust the sound at the final stage.			
DIST	Distortion	B	DRIVE	Drive	0–100 [%]
		C	LEVEL	Level	–Inf, –84.9 – 0.0 [dB]
		E	EQFREQ	PEQ Frequency	20–20000 [Hz]
		F	EQGAIN	PEQ Gain	–18.0 – +18.0 [dB]
		Use the DRIVE parameter to get effects from a gentle vacuum tube-like distortion to a powerful wave-crunching distorted sound. A parameter equalizer is placed later in the series, which lets you create a diverse range of sounds.			
G.AMP	Guitar Amp	B	DRIVE	Drive	0.0–100.0 [%]
		C	TYPE	Amp Type	VOX AC15, VOX AC15TB, VOX AC30, VOX AC30TB, UK Blues, UK 70'S, UK 80'S, UK 90'S, UK Modern, US Modern, US HiGain, Boutique OD, Boutique CL, Black 2x12, Tweed 1x12, Tweed 4x10
		E	HEQ	High EQ	0–100 [%]
		F	VOLUME	Volume	–Inf, –84.9 – +12.0 [dB]
		This monaural effect models guitar amp and speaker effects ranging from delicate saturation to roaring distortion.			

Effect name		Knob	Parameter name		Range
Display	Full name		Display	Full name	
DEC	Decimator	B	MIX	Dry:Wet Mix	0–100
		C	FREQ	Sampling Frequency	1000–48000 [Hz]
		E	BIT	Bit Resolution	4.0–24.0
		F	DAMP	High Damping	0–100 [%]
		Adds a lo-fi digital device-like feel. Use the FREQ parameter to control the sampling frequency and the BIT parameter to reduce the data bit length, each for a different kind of lo-fi texture.			
GRAIN	Grain Shifter	B	MIX	Dry:Wet Mix	0–100
		C	TIME	Time Frame	0–100 [%]
		E	SPEED	LFO Speed	1/48–4/1
		F	RETRIG	Retrigger	Off, Mod Whl, Damper, Note On, Velocity, LFO1, LFO2, LFO3
		This cuts out the short waveforms from the input signal and plays them back repeatedly, for an effect that changes the signal into a mechanical sound. The TIME parameter sets the length of the waveform to cut, and the SPEED parameter sets how fast to switch between the waveforms.			
LIMIT	Master Limiter	B	THRE	Threshold	–30.0 – 0.0 [dB]
		C	CEIL	Out Ceiling	–30.0 – 0.0 [dB]
		E	REL	Release	0.65–1000.00 [msec]
		This effect averages out the changes in volume of the input signal. Only signals that exceed the specified level will be compressed, which brings down unnecessary peaks in sound. The THRE parameter sets the level at which the compression is applied, and the CEIL parameter sets the output level.			
COMP	Compressor	B	MIX	Dry:Wet Mix	0–100
		C	SENS	Sensitivity	0–100
		E	ATTACK	Attack	0–100
		F	LEVEL	Output Level	–Inf, –84.9–0.0 [dB]
		This compressor models the extremely popular clean-sounding pedal effects.			
DLY/DLY 🎵	Delay/Delay (BPM)	B	LEVEL	Delay Level	0–100
		C	FDBK	Feedback	0–100 [%]
		E	DLY L	Delay Time L	0 [msec] – 2.73 [sec] / 1/48–4/1
		F	DLY R	Delay Time R	0 [msec] – 2.73 [sec] / 1/48–4/1
		This is a simple stereo delay with feedback.			
PDLY/PDL 🎵	Autopan Dly/Autopan Dly(BPM)	B	LEVEL	Delay Level	0–100
		C	DEPTH	Auto Pan Depth	0–100 [%]
		E	DLY	Delay Time	0 [msec] – 1.36 [sec] / 1/48–4/1
		F	SPEED	Speed	0.020–20.000 [Hz] / 1/48–4/1
		A stereo delay that pans the delay sound left and right using an LFO.			
TDLY/TDL 🎵	Tape Echo/Tape Echo (BPM)	B	LEVEL	Delay Level	0–100
		C	FDBK	Feedback	0–100 [%]
		E	DLY	Delay Time	0 [msec] – 2.7000 [sec] / 1/48–4/1
		F	DAMP	Damping	–100.0 – +100.0 [%]
		This effect models tape saturation and tape echo. The DAMP parameter sets the amount of high-end and low-end attenuation.			

Effect name		Knob	Parameter name		Range
Display	Full name		Display	Full name	
REF	Early Reflection	B	LEVEL	Reverb Level	0–100
		C	TYPE	Type	Sharp, Loose, Modulated, Reverse
		E	TIME	Reverb Time	10 [msec] – 1.600 [sec]
		F	HEQ	High EQ Gain	–15.0 – +15.0 [dB]
		This effect extracts only the initial reflections of the sound from the simulated reverb sounds, giving a feeling of intimacy and presence. You can select the decay curve of the reverb using the TYPE parameter.			
REVERB	Reverb	B	LEVEL	Reverb Level	0–100
		C	TYPE	Type	Hall, Large Hall, Smooth Hall, Chamber, Plate, Room, Wet Room, Space
		E	TIME	Reverb Time	200 [msec] – 10.000 [sec] (note: this differs with each reverb type)
		F	TONE	Tone	500–20000 [Hz]
		A smooth, high-definition reverb with a natural echoing sound. A "Space" type is also available with a long pre-delay and release, to add to the standard Room, Hall, Chamber and Plate types.			
SHVERB	Shimmer Reverb	B	LEVEL	Reverb Level	0–100
		C	TYPE	Type	Clear, Riser, Submarine, Horror
		E	TIME	Reverb Time	0–100 [%]
		F	TONE	Tone	0–100 [%]
		A reverb with an added pitch-shifter effect. The pitch shift width changes depending on the TYPE parameter, with sounds ranging from sparkling to mysterious effects.			
SPRING	Spring Reverb	B	LEVEL	Reverb Level	0–100
		C	LENGTH	Spring Length	0–100 [%]
		E	TIME	Reverb Time	49 [msec] – 4.0000 [sec]
		F	CHIRP	Chirp	0–100 [%]
		This reverb simulates the spring reverb sound used in some guitar amps and organs. You can control the characteristics of the spring to be modeled using the LENGTH and CHIRP parameters.			

Appendix

Connecting the opsix to a MIDI device or computer

Use a MIDI connection if you wish to use the opsix's keyboard and controllers to control an external MIDI device, or to use another MIDI keyboard or a sequencer to play the opsix's sound generator.

MIDI stands for Musical Instrument Digital Interface, and is a worldwide standard for exchanging various types of musical data between electronic musical instruments and computers.

When MIDI cables are used to connect two or more MIDI devices, performance data can be exchanged between the devices, even if they were made by different manufacturers. A USB cable can also be used to connect the opsix to a personal computer.

Connecting/ a computer or MIDI device

- **Connecting the opsix to a computer via USB**

The opsix is a class-compliant USB-MIDI device, and requires no driver for basic MIDI functionality.

If you wish to use librarian software with the opsix, you will need to connect to the opsix using a USB cable. For details, please see the documentation included with the librarian.

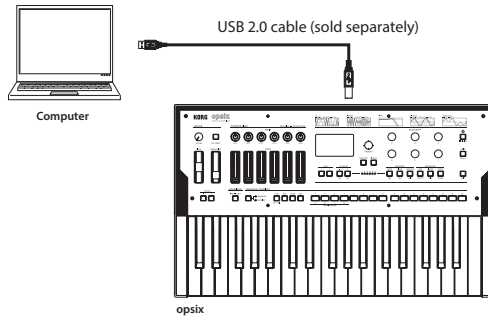

- **Controlling an external MIDI tone generator from the opsix**

If you want to use the opsix's keyboard, controllers, step sequencer and so on to play sounds on or control an external MIDI tone generator, connect the opsix's MIDI OUT connector to the external MIDI tone generator's MIDI IN connector using a MIDI cable.

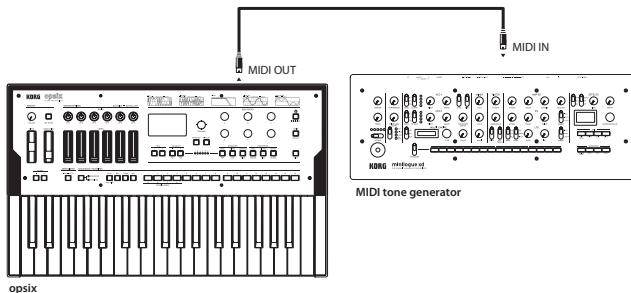

- **Controlling the opsix from an external MIDI device**

If you want to play or control the opsix from another MIDI keyboard, sequencer, or other device, connect the MIDI OUT jack of the external MIDI device to the opsix's MIDI IN jack with a MIDI cable.

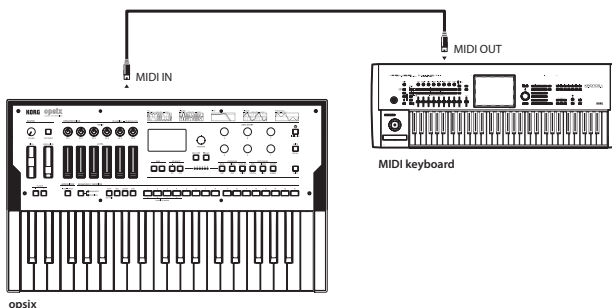

- **Connecting the opsix to an external MIDI sequencer, computer or similar device**

You might want to play the opsix's keyboard and record your performance on an external MIDI sequencer or computer (connected using the MIDI interface), and then play the opsix while monitoring or playing back what you recorded. You also might want to use the opsix as both an input device for playing notes and as a MIDI tone generator. In either case, you'll need to connect the MIDI OUT jacks to the MIDI IN jacks on both the opsix and the external MIDI sequencer or computer.

⚠ Some MIDI interface devices may be unable to transmit or receive MIDI system exclusive messages to or from the opsix.

Tip: It's convenient to use the USB jack when connecting the opsix to a personal computer.

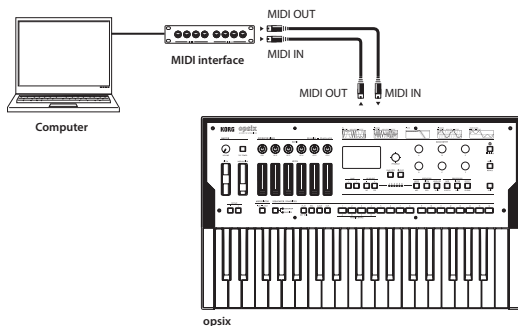

MIDI-related settings

MIDI channel settings

In order to exchange data with a connected external MIDI device, you must set the opsix's MIDI channel to match the MIDI channel of the external MIDI device. Use the steps below to set the MIDI channel.

1. Press the EFFECT button while holding down the SHIFT button, and select the GLOBAL page group.
2. Press the PAGE < and > buttons to display the MIDI page.
3. Use the OP SELECT +/- buttons to select the Global channel (MIDI channel).
4. Use the DATA ENTRY C or F knob to change the MIDI channel.
5. Set the MIDI channel of the external MIDI device that you connected.

Tip: When synchronizing to an external MIDI device, refer to that device's owner's manual.

MIDI LOCAL setting when connecting an external MIDI sequencer or computer

If the opsix is connected to an external MIDI sequencer or computer, and the Echo Back setting of the external MIDI sequencer or computer is turned on while the opsix's local control setting is also on, the performance data generated when you play the opsix's keyboard will be sent to the external MIDI sequencer, and will also be echoed back to sound the opsix's tone generator a second time. To prevent this kind of echo-back from happening, you can simply turn off local control on the opsix. This setting is found on the MIDI page in the GLOBAL page group. Switch "Local Control" (→p.77) to "Off".

Synchronizing playback of the step sequencer and arpeggiator

Use the "Clock" setting (→p.77) on the MIDI page of the GLOBAL page group to set whether the opsix will be the master (the device controlling the synchronization) or the slave (the device being controlled) when the step sequencer or arpeggiator is played.

Tip: When synchronizing to an external MIDI device, refer to that device's owner's manual.

- **Using the opsix as master and the external MIDI device as slave**

Connect the opsix's MIDI OUT connector to your external MIDI device's MIDI IN connector.

On the MIDI page of the GLOBAL page group, set "Clock" (→p.77) to "Intern" (Internal) to make the opsix the master. This will make the opsix transmit MIDI timing clocks.

Configure the external MIDI device to receive clock data via MIDI. Your external MIDI device (a sequencer, rhythm machine and so on) will operate at the tempo you specify using the TEMPO (→p.64) parameter on the SEQUENCER page, SEQ page group.

- **Using the external MIDI device as master and the opsix as slave**

Connect the opsix's MIDI IN connector to your external MIDI device's MIDI OUT connector.

On the MIDI page of the GLOBAL page group, set "Clock" (→p.77) to "Extern" (External MIDI) to make the opsix the slave. This will make the opsix receive MIDI timing clocks.

Configure the external MIDI device to transmit clock data (as the master). The arpeggiator on the opsix will operate in time with the external MIDI device (sequencer, rhythm machine, etc.).

Tip: If "Clock" (→p.77) in the MIDI page of the GLOBAL page group is set to "Auto", the opsix will automatically operate in "Extern" (External MIDI) mode when it receives a MIDI clock from an external MIDI device connected to the opsix's MIDI IN connector. Otherwise, the opsix will operate in "Intern (Internal)" mode.

Librarian software

The opsix Sound Librarian software works on macOS and Windows, and can be downloaded at www.korg.com.

For details on the opsix Sound Librarian, please see the documentation included with the librarian.

Loading DX7 sounds

The opsix can receive sounds from the Yamaha DX7 in the form of system exclusive messages, and convert this data into programs that are playable on the opsix.

There are many DX7 sounds (.SYX files) that can be searched for and downloaded over the Internet. You can use an application to send the .SYX sound files you download to import and use on the opsix.

The programs that you convert for use on the opsix can be transformed into brand-new sounds using the opsix's unique functionality, and you can use the sequencer, arpeggiator and effects to process these sounds as well.

- ⚠ Note that as the opsix and DX7 use different parameter configurations, the conversion will not be perfect, and some sounds might end up quite different from the way they sounded on the DX7.

System exclusive messages that can be loaded

The following conditions must be met in order to receive system exclusive messages from the DX7.

- The messages must include a complete bank of 32 DX7 sounds. Messages containing only one sound cannot be loaded.
- The system exclusive format must be that of the first-generation DX7, which is supported by six-Operator FM synthesizers and the DX9. System exclusive messages from FM synthesizers like the four-Operator DX, TX81Z, SY77 and so on cannot be loaded.

Receiving DX7 system exclusive messages

1. Select the first program number where the programs will be loaded using the PROGRAM knob.

- ⚠ The 32 programs beginning with the program number you selected will be overwritten. We recommend that you make sure that none of the data you need will be overwritten.

2. Transmit the system exclusive messages from your DX7, computer.

You will see the dialog box shown below.

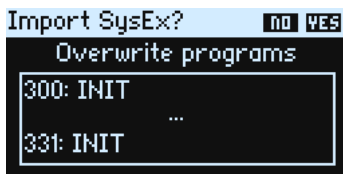

Tip: You can change the destination program number where your sounds will be loaded by using the PROGRAM knob.

3. Press the YES button to load the programs received.

Tip: Press the NO button to cancel.

Error messages that may occur when loading

You may see the following error messages if the opsix is unable to load the data.

No readable data

If the data is less than 4,104 bytes, or if the SysEx header is not in DX7 Program Bank format, the data cannot be loaded.

Unsupported data

Although the header is correct, the file cannot be loaded because the checksum doesn't match and the data in the file is corrupt.

Restoring the opsix to factory-set default settings

You can restore the opsix's preset programs and global settings to their original factory-set state.

⚠ Never turn off the power while data is being loaded. Doing so may corrupt the internal data.

1. Turn off the power of the opsix.
2. While holding down the SHIFT button and the WRITE/RECALL button, turn the opsix on. "Factory Reset" will be shown on the display.



3. When the message "WHAT DO YOU WANT TO RESET?" is displayed, turn the PROGRAM knob to select the items you want to restore to factory default settings (Preset, Global or All).

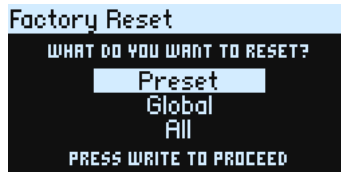

⚠ If you select "ALL" and execute, all user programs that are saved on the opsix will be erased as well.

4. Press the WRITE button.

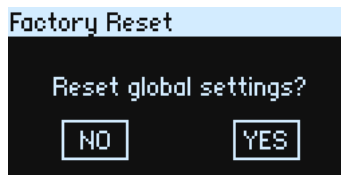

5. Press the OP SELECT + / YES button. "Resetting..." will appear on the display.

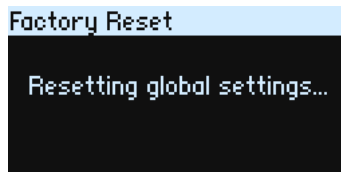

6. If the following message is displayed, turn the power of the opsix off and back on again. The factory-set default data will be reloaded, and the opsix will be restored to its factory-set default state.

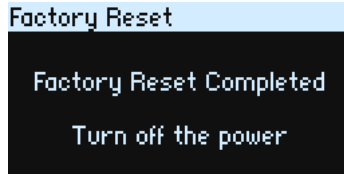

Troubleshooting

If the opsix is not operating as expected, check the following points.

Power does not turn on.

- Is the AC adapter connected to an outlet?
- Are you pressing and holding down the  (power) button when turning on the opsix?

No sound is heard when the keys are played.

- Have you correctly connected the jacks of this keyboard to headphones or powered monitor speakers?
- Check that the powered speakers or other amplification to which the keyboard is connected is turned on, and that the volume is turned up so that you can hear it.
- Make sure the VOLUME knob is not turned all the way to the left.
- Is the Local Control setting on the GLOBAL MIDI page set to “On”? (→p.77)
- Are the parameters related to volume set to “0”?
- Is the cutoff value on the FILTER page set too low or too high? (→p.58)

Sounds cannot be edited.

- If the position indicated by the knob and the value shown on the main display are different when operating a knob: When Knob Mode on the GLOBAL CTRL page is set to “Jump”, the actual parameter value may be different from the position indicated by the knob. (→p.80)
- If the edited program, has not remained in memory: You may have turned off the power before the data was saved. In the case of programs, the edited settings will be discarded when you select another program. Save your edited program before turning off the power or switching programs.

The program settings can't be saved.

- If the program you edited was not saved, did you use the PROGRAM knob to correctly select the save location (program number)?

The arpeggiator won't start playing.

- Is the ARPEGGIATOR button lit or blinking?
- Are the Clock settings on the GLOBAL MIDI page set correctly? (→p.77)

The opsix is not responding to MIDI data transmitted from my external device.

- Are the MIDI and USB cables connected correctly?
- Are the MIDI channels on the external MIDI device that is transmitting the data and on the opsix set to the same channel?
- Are the settings on the GLOBAL MIDI page such as Rx Transport, Rx Prog Chg, Rx CC, Rx Pitch Bend and so forth set to “On”? (→p.78)

Transpose, velocity curve and arpeggiator data are not being recognized correctly.

- Are the Convert Position settings on the GLOBAL MIDI page set correctly? (→p.77)

The sound will not stop.

- Is the EG release time on Operators that are functioning as carriers set too long?
- Press the  (ALGO) button on the HOME/ALGO page to make the notes stop that are now playing.
- If the sound stops when you plug a pedal into the DAMPER jack and press the pedal, the pedal polarity might be detected incorrectly. Try unplugging and plugging the pedal in again, as this problem can occur when the pedal is being pressed while the jack is being inserted, or if the jack is inserted very slowly.

The sound is distorted.

- Depending on the current program and how you are playing, having the VOLUME knob set to a large value may cause the output of the opsix to become distorted. If this happens, please turn down the VOLUME knob and adjust the volume on your mixer or amp.

Specifications

Keyboard:	opsix: 37 keys (velocity and release-velocity sensitive) opsix SE: 61 keys, Natural Touch keyboard (velocity and release-velocity sensitive, with aftertouch)
Maximum Polyphony:	opsix: 32 voices (the maximum number of voices depends on the settings) opsix SE: 80 voices (the maximum number of voices depends on the settings) opsix module: 80 voices (the maximum number of voices depends on the settings)
Sound generating system:	Altered FM sound generator
Structure:	6 operators, 1 filter, 3 EGs, 3 LFOs, 3 effects, step sequencer, arpeggiator Algorithm: 40 presets + user algorithm (unique to each program) Operator: 6 modes (FM, Ring Mod., Filter, Filter FM, Wave Folder, Effect) Oscillator waveform: 23 waveforms (Sine, Sine 12bit, Sine 8bit, Triangle, Saw, Saw HD, Square, Square HD, Additive Saw3, Additive Sqr3, Additive Tri3, Additive 12345, Additive 1+2, Additive 1+3, Additive 1+4, Additive 1+5, Additive 1+6, Additive 1+7, Additive 1+8, Noise S/H, Noise White, Noise Pink, Noise Blue) Filter: 11 types (LPF 12, LPF 24, LPF MS-20, LPF POLY6, HPF 12, HPF 24, HPF MS-20, BPF 6, BPF 12, BRP 6, BRP 12) EG: ADSR LFO: 23 waveforms (Triangle, Saw Down, Saw Up, Square, Sine, Sample&Hold, Guitar, Exp. Triangle, Exp. Saw Down, Exp. Saw Up, Step4 Triangle, Step6 Triangle, Step4 Saw Down, Step6 Saw Down, StepRnd:Time, StepRnd:Lvl&Time, StepRnd:Level, Random:Time, Random:Lvl&Time, Triangle + , Saw Down + , Saw Up + , Square +) V.Patch: 12 routings Effect: 30 types (Chorus, Unison Ensemble, Phaser, Phaser (BPM) , Auto Pan, Auto Pan (BPM), Flanger, Flanger (BPM) , Rotary Speaker, Auto Wah, Exciter, Enhancer, LFO Filter, 3-Band EQ, Distortion, Guitar Amp, Decimator, Grain Shifter, Master Limiter, Compressor, Delay, Delay (BPM) , Autopan Dly, Autopan, Dly (BPM), Tape Echo, Tape Echo (BPM) , Early Reflection, Reverb, Shimmer Reverb, Spring Reverb) Sequencer: Step Sequencer (up to 16 steps, up to 6 notes per step) , Motion Sequencer (up to 6 lanes) Arpeggiator: 7 patterns (MANUAL, UP, DOWN, ALT1, ALT2, RANDOM, TRIGGER)

Number of programs:	500 (350 preset programs and 150 user programs as the factory-set default) FAVORITE: 64 (16 Slots × 4 Banks)
Controllers:	MODULATION wheel*, PITCH wheel*, RATIO OP 1–6 knobs, LEVEL OP 1–6 sliders, DATA ENTRY A–F knobs * Excluding the opsix module
Inputs/outputs:	Headphone (6.3 mm stereo phone jack), OUTPUT L/MONO and R (impedance-balanced 6.3 mm TRS phone jacks), DAMPER (6.3 mm phone jack, half-damper not supported), MIDI IN and OUT connectors, USB B port
Power supply:	AC adapter (DC12V, )
Power consumption:	5 W
Dimensions (W × D × H):	opsix: 565 × 338 × 90 mm/22.24" × 13.31" × 3.54" opsix SE: 1014 × 344 × 108 mm/39.92" × 13.54" × 4.25" opsix module: 483 × 172 × 104 mm/19.02" × 6.77" × 4.09" (With rack-mounting adapters)
Weight:	opsix: 2.9 kg/6.93 lb opsix SE: 8.9 kg/19.62 lb opsix module: 1.7 kg/3.75 lb (With rack-mounting adapters)
Included items:	opsix: AC adapter, Precautions, Quick Start Guide opsix SE: AC adapter, Quick Start Guide opsix module: AC adapter, Quick Start Guide
Accessories (sold separately):	DS-1H damper pedal, PS-1 pedal switch, PS-3 pedal switch

* Specifications and appearance are subject to change without notice for improvement.

Program Name List

No.	Name	Category	Programmer	Favorite	V1 No.**
001	Dat Electric Piano	Keyboard	Francis Preve	C03	20
002	Original FM EP	Keyboard	Luke Edwards		21
003	FM E.Piano Basic	Keyboard	Katsunori UJIE	B03	Ver.2
004	FM Dyno Tine EP	Keyboard	KORG Inc.		22
005	SynBass/EP Split	Keyboard	Luke Edwards		Ver.2
006	80's Sprit Split	Keyboard	KORG Inc.		23
007	Waveshape EP	Keyboard	KORG Inc.		Ver.2
008	Shooting Star EP	Keyboard	KORG Inc.		Ver.2
009	Punchy Wire Piano	Keyboard	Dean Walliss		Ver.2
010	Just Hang On	Keyboard	Luke Edwards		30
011	FM Vamp	Keyboard	Luke Edwards		31
012	Bouncey	Keyboard	Luke Edwards		29
013	Soft Pad EP	Keyboard	KORG Inc.		Ver.2
014	Ambi Sines	Keyboard	Francis Preve		137
015	Overcompressed	Keyboard	Matt Pike		Ver.2
016	Extra Knock EP	Keyboard	Matt Pike		Ver.2
017	Roads and Roads	Keyboard	Francis Preve		19
018	FM EP Body	Keyboard	KORG Inc.		18
019	OP Delay E.Piano	Keyboard	Katsunori UJIE		Ver.2
020	Ana Eleki Piano	Keyboard	Katsunori UJIE		Ver.2
021	A.Piano Seed	Keyboard	KORG Inc.		25
022	Comb Piano	Keyboard	KORG Inc.	A03	Ver.2
023	Wurly EP	Keyboard	KORG Inc.		28
024	Dynamik	Keyboard	Francis Preve		24
025	Gritty Timber	Keyboard	Dean Walliss		Ver.2
026	Portrait EP	Keyboard	KORG Inc.		26
027	Digital Plucker	Keyboard	KORG Inc.		43
028	Layerz	Keyboard	Francis Preve		41
029	Steam Church	Keyboard	Tomohiro Nakamura		40
030	Mutated Piano	Keyboard	Francis Preve		27
031	Playable Bell	Keyboard	Luke Edwards		62
032	Unsteady	Keyboard	Dean Walliss		Ver.2
033	Folk Piano	Keyboard	Dean Walliss		Ver.2
034	FM Syntar	Keyboard	Minoru Koike		42
035	Comb Dulcimer	Keyboard	KORG Inc.		Ver.2
036	OP Comb Sitar	Keyboard	Katsunori UJIE		Ver.2
037	Metalic Pluck	Keyboard	KORG Inc.	B11	Ver.2
038	Metaklav	Keyboard	Francis Preve		48
039	Reso Phase Clav	Keyboard	Minoru Koike		44
040	Clav O' Frog	Keyboard	Minoru Koike		45
041	MW Phasing Clav	Keyboard	KORG Inc.		Ver.2
042	Wave Shaper Clav	Keyboard	Katsunori UJIE		Ver.2
043	Pulse Clav	Keyboard	KORG Inc.		46
044	WahTalk	Keyboard	Luke Edwards		47
045	DrawSlider Organ	Keyboard	KORG Inc.		34
046	Tone Wheel Organ	Keyboard	Katsunori UJIE	A11	Ver.2

No.	Name	Category	Programmer	Favorite	V1 No.**
047	Paisley Organ	Keyboard	Francis Preve		38
048	Space Organ	Keyboard	Luke Edwards		35
049	Lausanne Organ	Keyboard	Francis Preve		37
050	Ring Pipe Organ	Keyboard	Katsunori UJIE		Ver.2
051	Glide Sine	Keyboard	KORG Inc.		36
052	OPcordion	Keyboard	Tomohiro Nakamura	C11	39
053	Jazzy Guitar	Keyboard	Francis Preve		49
054	EG 2 EP	Keyboard	Tomohiro Nakamura		50
055	Bright Plectrum	Keyboard	Dean Walliss		51
056	Mod Crunch	Keyboard	Luke Edwards		52
057	Strum Down	Keyboard	Luke Edwards	A14	53
058	Wire Guitar	Keyboard	Dean Walliss		Ver.2
059	Slow Ambient Guitar	Keyboard	Luke Edwards		Ver.2
060	Distant Memories	Keyboard	Luke Edwards	C14	Ver.2
061	Syn Marimba	Bell/Decay	Katsunori UJIE	B14	Ver.2
062	FMarimba	Bell/Decay	Francis Preve		127
063	Membrane Pluck	Bell/Decay	Matt Pike		123
064	Cold Coast	Bell/Decay	Tomohiro Nakamura		141
065	4 Tap Diffusion	Bell/Decay	Matt Pike		Ver.2
066	Hold For Glitches	Bell/Decay	Matt Pike		124
067	Dynamic Tin Bells	Bell/Decay	Dean Walliss		125
068	Delay = LFO	Bell/Decay	Matt Pike		Ver.2
069	LFO Grooves	Bell/Decay	Matt Pike		126
070	Glasklavier	Bell/Decay	Minoru Koike		128
071	Lonely Star	Bell/Decay	Luke Edwards	A06	Ver.2
072	Crystal Syn Bell	Bell/Decay	Katsunori UJIE		Ver.2
073	Maverick Bells	Bell/Decay	Luke Edwards		129
074	Mallet Piano	Bell/Decay	Minoru Koike		133
075	Percussion	Bell/Decay	VROMM		132
076	Ring Chime	Bell/Decay	Dean Walliss		Ver.2
077	Zen Chime	Bell/Decay	Francis Preve		134
078	4 Bar Alterations	Bell/Decay	Matt Pike		136
079	Crystal Bells	Bell/Decay	Richard Devine		135
080	Shimmer & Folder	Bell/Decay	KORG Inc.	C06	139
081	1983	Bell/Decay	Luke Edwards		Ver.2
082	MIDI Stack	Bell/Decay	Francis Preve		33
083	FM Heaven	Bell/Decay	Luke Edwards		Ver.2
084	Frantasia	Bell/Decay	Francis Preve		130
085	Icy Shimmer	Bell/Decay	Luke Edwards		Ver.2
086	FM Airy Bell	Bell/Decay	KORG Inc.		Ver.2
087	Snow Ball	Bell/Decay	KORG Inc.	B06	Ver.2
088	Festival of Wind	Bell/Decay	Francis Preve		138
089	Ruin Chatters	Bell/Decay	Tomohiro Nakamura		144
090	FINLAND	Bell/Decay	Tomohiro Nakamura		143
091	Night Sky	Bell/Decay	Dean Walliss		Ver.2
092	Ritual Decay	Bell/Decay	Francis Preve		142
093	Plinq Plunq	Bell/Decay	Francis Preve		145
094	Bureon Lead	Bell/Decay	Richard Devine		147
095	FM Wind Chime	Bell/Decay	Tomohiro Nakamura		146

No.	Name	Category	Programmer	Favorite	V1 No.**
096	Introduction	Motion	Tomohiro Nakamura		4
097	Cycles	Motion	Tomohiro Nakamura	C04	2
098	Cyber Pad Bell	Motion	Tomohiro Nakamura		1
099	Pluck Drip	Motion	KORG Inc.	A10	Ver.2
100	Rand Spacing Pulses	Motion	Matt Pike	C10	Ver.2
101	Bounce	Motion	Matt Pike		Ver.2
102	Angklung Lore	Motion	KORG Inc.		Ver.2
103	Juicy Square	Motion	Tomohiro Nakamura		16
104	Organic Glow	Motion	Richard Devine	B04	5
105	FuwaFuwa	Motion	Tomohiro Nakamura		15
106	Memories Pad	Motion	Richard Devine		11
107	MOD Storm	Motion	Minoru Koike	A04	7
108	Spinners	Motion	Richard Devine		8
109	Shifting 9th	Motion	Matt Pike		Ver.2
110	MS-20 Poly Cascade	Motion	Matt Pike		14
111	Steppy World	Motion	Richard Devine		9
112	Fairy Tweets	Motion	Tomohiro Nakamura	B10	10
113	DETROITrill	Motion	Tomohiro Nakamura		13
114	Blue Cloud	Motion	Tomohiro Nakamura		12
115	Aliasing Space	Motion	Tomohiro Nakamura		6
116	Soft FM Brass	FastSynth	KORG Inc.		55
117	Dyno FM Brass	FastSynth	KORG Inc.	B02	54
118	Bright FM Brass	FastSynth	KORG Inc.		56
119	Sweep Stab	FastSynth	Minoru Koike		57
120	Blended Brass	FastSynth	Francis Preve		58
121	Filtered Saws	FastSynth	Dean Walliss	A02	59
122	Franalog	FastSynth	Francis Preve		60
123	Phasepulse	FastSynth	Francis Preve		62
124	Supersawyer	FastSynth	Francis Preve		63
125	Folder Comp	FastSynth	KORG Inc.		64
126	VelociStabber	FastSynth	Luke Edwards		Ver.2
127	Inspirational Story	FastSynth	Luke Edwards		Ver.2
128	5th Stab	FastSynth	Tomohiro Nakamura	C02	73
129	Moody Chord Stabs	FastSynth	Dean Walliss		61
130	Plucky Pad	FastSynth	Luke Edwards		65
131	Fuzzy Glass	FastSynth	Dean Walliss		66
132	Prog Pluck	FastSynth	Tomohiro Nakamura		67
133	Purple Fringing	FastSynth	Tomohiro Nakamura		68
134	Ring It On	FastSynth	Francis Preve		69
135	Velocity Hang	FastSynth	Matt Pike		70
136	Steamy Comp	FastSynth	Katsunori UJIE		Ver.2
137	Faded Pad	FastSynth	Minoru Koike		72
138	Shaky Dynamic Pad	FastSynth	Dean Walliss		Ver.2
139	Hard Sync Stab	FastSynth	Minoru Koike		71
140	Chordstreaming	FastSynth	KORG Inc.		74
141	Dark Stages	FastSynth	VROMM		75
142	DUBSTAB	FastSynth	Tomohiro Nakamura		76
143	DUBSTAB 2020	FastSynth	Tomohiro Nakamura		77
144	Slight Touch	FastSynth	KORG Inc.		79

No.	Name	Category	Programmer	Favorite	V1 No.**
145	Triplet Split	FastSynth	Matt Pike		80
146	Rasp & Static	SlowSynth	Matt Pike	A01	Ver.2
147	Wasps	SlowSynth	Matt Pike		Ver.2
148	Dulled Rhythms	SlowSynth	Matt Pike		17
149	Tremoloverb	SlowSynth	KORG Inc.		102
150	FM Ring Mod Pad	SlowSynth	Katsunori UJIE		Ver.2
151	Flexpad	SlowSynth	Francis Preve		83
152	Immortal Pad	SlowSynth	Luke Edwards		81
153	Contemplation	SlowSynth	Luke Edwards		Ver.2
154	Slow Gear Clav	SlowSynth	Luke Edwards		82
155	Mod Those Bells	SlowSynth	Luke Edwards		84
156	Distant Wave Voices	SlowSynth	Dean Walliss	C01	Ver.2
157	FilterFM Pad	SlowSynth	KORG Inc.		86
158	Floating Phase Pad	SlowSynth	KORG Inc.		Ver.2
159	Moist Vibe	SlowSynth	KORG Inc.		104
160	Feel The Pump	SlowSynth	Luke Edwards	B12	Ver.2
161	Quiet Motion	SlowSynth	Luke Edwards		Ver.2
162	Ninja Pad FX	SlowSynth	Luke Edwards		87
163	Harmonic Waiting Room	SlowSynth	Luke Edwards		85
164	Surged Saws	SlowSynth	Luke Edwards		Ver.2
165	Slow Vibe	SlowSynth	KORG Inc.		88
166	Glide Saw	SlowSynth	KORG Inc.		89
167	Exit Code	SlowSynth	KORG Inc.		90
168	Lab Coats	SlowSynth	Matt Pike	B01	91
169	Choral Aliasing	SlowSynth	Minoru Koike		92
170	Chill Pad ARP	SlowSynth	Minoru Koike		93
171	Floating Whistle	SlowSynth	KORG Inc.		94
172	Unbreakable	SlowSynth	Luke Edwards		95
173	Star Pad	SlowSynth	Richard Devine	C12	96
174	Ghost Voices	SlowSynth	Luke Edwards	A12	Ver.2
175	Stellar Choir	SlowSynth	Francis Preve		97
176	Holy Choir	SlowSynth	Luke Edwards		98
177	Retro Choir	SlowSynth	Dean Walliss		99
178	Formant Pad	SlowSynth	KORG Inc.		100
179	Throat FM	SlowSynth	Minoru Koike		101
180	Fog pad	SlowSynth	VROMM		103
181	Dark Pad	Pad/Strings	KORG Inc.		105
182	Lush Pad	Pad/Strings	Luke Edwards		106
183	NotePad LFO	Pad/Strings	Luke Edwards		107
184	opsix Concrete	Pad/Strings	Luke Edwards	C08	Ver.2
185	Sine Width Mod	Pad/Strings	KORG Inc.		108
186	Deep Space	Pad/Strings	Luke Edwards		110
187	Square Bear Pad	Pad/Strings	Luke Edwards		109
188	New Motion	Pad/Strings	Luke Edwards		Ver.2
189	Pad Mod Fizz	Pad/Strings	Luke Edwards		112
190	Sun Baked Strings	Pad/Strings	Matt Pike		111
191	Retro Synth Strings	Pad/Strings	KORG Inc.		114
192	Breezy Pad	Pad/Strings	Dean Walliss	A08	Ver.2
193	Smooth Split	Pad/Strings	Luke Edwards		113

No.	Name	Category	Programmer	Favorite	V1 No.**
194	Comb Strings	Pad/Strings	Matt Pike	B08	Ver.2
195	Aluminium Pad	Pad/Strings	Luke Edwards		115
196	Gently Strings Pad	Pad/Strings	Katsunori UJIE		Ver.2
197	Galactic Orchestra	Pad/Strings	Francis Preve		116
198	Velocity Pad	Pad/Strings	Dean Walliss		117
199	Simple PWM	Pad/Strings	Minoru Koike		118
200	Feel The Warmth	Pad/Strings	Luke Edwards		Ver.2
201	1985 Bed	Pad/Strings	Luke Edwards		119
202	Engagement Pad	Pad/Strings	Matt Pike		120
203	Digital Insects	Pad/Strings	Minoru Koike		121
204	Self Arping Bells	Pad/Strings	Matt Pike		122
205	Glass Waves	Pad/Strings	Luke Edwards		Ver.2
206	FM Elec Bass	Bass	KORG Inc.		Ver.2
207	FM Slap	Bass	Luke Edwards	C13	148
208	Punchy SynBass	Bass	Katsunori UJIE		Ver.2
209	Evolving Bass	Bass	Dean Walliss		149
210	90's House Bass	Bass	KORG Inc.	B13	Ver.2
211	Funk Bass	Bass	KORG Inc.		151
212	Laid Bass	Bass	KORG Inc.		154
213	Fonk Bass	Bass	Luke Edwards		Ver.2
214	Clang Bass	Bass	Dean Walliss		153
215	Sweepy Saw Bass	Bass	Dean Walliss		152
216	Aphasin Bass	Bass	Matt Pike		155
217	Fwonky Bass	Bass	Dean Walliss		150
218	Barking Bass	Bass	Minoru Koike		156
219	Legato OctBS	Bass	Tomohiro Nakamura		158
220	Analog<=>FM Bass	Bass	Tomohiro Nakamura		159
221	Subby Bass	Bass	Luke Edwards		Ver.2
222	Jazz Bass	Bass	Francis Preve		160
223	Worm Bass	Bass	KORG Inc.		161
224	BoBgog'n'FMbass	Bass	Tomohiro Nakamura		162
225	Concrete Bass	Bass	KORG Inc.		163
226	Core Bass	Bass	KORG Inc.		164
227	Unlucky Bass	Bass	KORG Inc.		165
228	FLDR Bass	Bass	Minoru Koike		166
229	Big Moon	Bass	VROMM		169
230	Ven aqui ya	Bass	VROMM		168
231	Jungle Drum Bass	Bass	VROMM		170
232	Sub'n Pluck	Bass	KORG Inc.		167
233	Spread Love	Bass	VROMM		171
234	Harsh Bass	Bass	Matt Pike		172
235	Droid Bass	Bass	Matt Pike		175
236	Didge Bass	Bass	Matt Pike		Ver.2
237	Cinematic FB Doom	Bass	Matt Pike		Ver.2
238	Thick Screamer	Bass	Matt Pike	A13	Ver.2
239	Fold Form Blend	Bass	Matt Pike		Ver.2
240	Dirty Trautonium	Bass	Matt Pike		Ver.2
241	Mod Saw Lead	Lead	Luke Edwards	A05	Ver.2
242	Xover Bright Lead	Lead	Dean Walliss		191

No.	Name	Category	Programmer	Favorite	V1 No.**
243	Mega Saw	Lead	Luke Edwards		187
244	Mixed Pulse Lead	Lead	KORG Inc.		194
245	Mono Sweep Lead	Lead	KORG Inc.		180
246	C.C.M SynLead	Lead	Katsunori UJIE	B05	Ver.2
247	Pure 80's Lead	Lead	Luke Edwards		179
248	Rustic Lead	Lead	Richard Devine		183
249	SimpLEAD	Lead	Luke Edwards		181
250	Theremax	Lead	Luke Edwards		176
251	Sonic Lead	Lead	Luke Edwards		177
252	Pray Lead	Lead	KORG Inc.		178
253	Brat LEAD	Lead	Luke Edwards		182
254	Fossil Lead	Lead	KORG Inc.		186
255	Fragile Seq	Lead	Dean Walliss		184
256	Koto Lead	Lead	Luke Edwards		185
257	Paper Lead	Lead	KORG Inc.		188
258	THE LEAD	Lead	Tomohiro Nakamura		190
259	Big Lead	Lead	KORG Inc.		192
260	Screamer	Lead	KORG Inc.		193
261	Dubz Lead	Lead	Luke Edwards		195
262	Hard Synchronicity	Lead	Francis Preve		196
263	Slippery Lead	Lead	Dean Walliss		Ver.2
264	Talky Lead	Lead	Luke Edwards		189
265	Rock God	Lead	Luke Edwards		Ver.2
266	Purple Dist EG	Lead	Katsunori UJIE	C05	Ver.2
267	Dynamic Wood	Arp/Seq	Matt Pike		197
268	Fairy Dust	Arp/Seq	Luke Edwards		198
269	Arp Swirls	Arp/Seq	Matt Pike	A09	Ver.2
270	ARP Flurry	Arp/Seq	Luke Edwards		Ver.2
271	Whistle & Guitar	Arp/Seq	Dean Walliss		Ver.2
272	Hybrid Pluck	Arp/Seq	Luke Edwards	C07	Ver.2
273	Deli Arp	Arp/Seq	Matt Pike		Ver.2
274	Trance Generation	Arp/Seq	Luke Edwards		199
275	Euphoria	Arp/Seq	Luke Edwards		Ver.2
276	Res Arps	Arp/Seq	Richard Devine		200
277	Mono to Poly	Arp/Seq	Matt Pike		201
278	NOS	Arp/Seq	Tomohiro Nakamura	B09	202
279	Dusty Wood	Arp/Seq	Dean Walliss		Ver.2
280	Algo Tripping MW	Arp/Seq	Matt Pike		140
281	Polyphonic Delays	Arp/Seq	Matt Pike		Ver.2
282	2Scenes	Arp/Seq	Tomohiro Nakamura		207
283	Binary Tines	Arp/Seq	Matt Pike		131
284	Dub Club	Arp/Seq	VROMM		78
285	Dance Stabs	Arp/Seq	Luke Edwards		Ver.2
286	Could You Repeat That?	Arp/Seq	Luke Edwards		Ver.2
287	Death Ladder	Arp/Seq	Luke Edwards		204
288	Obscure Arcade Game	Arp/Seq	Tomohiro Nakamura		205
289	Patternizer	Arp/Seq	Francis Preve		3
290	WS Pulse Anthem	Arp/Seq	Luke Edwards	A07	Ver.2
291	Mod Pulse +	Arp/Seq	Luke Edwards		Ver.2

No.	Name	Category	Programmer	Favorite	V1 No.**
292	Rhythmic Fold Bass	Arp/Seq	Matt Pike		157
293	Quadratic Chord Pulse	Arp/Seq	Matt Pike	B07	203
294	Hammerblade	Arp/Seq	Tomohiro Nakamura		208
295	Tension Taps	Arp/Seq	Matt Pike		209
296	Cosmic Pluck	Arp/Seq	Tomohiro Nakamura		206
297	Octave Gesture	Arp/Seq	Matt Pike		174
298	Fat Snake Bass	Arp/Seq	VROMM		173
299	Instant Techno	Arp/Seq	Matt Pike		210
300	Frost Beatz	Arp/Seq	Matt Pike		211
301	RAVE-ON!!	Arp/Seq	Tomohiro Nakamura		212
302	Hardgroove	Arp/Seq	Tomohiro Nakamura		213
303	Table Tapping	Arp/Seq	Matt Pike	C09	214
304	SAKURA	Arp/Seq	Tomohiro Nakamura		215
305	GHOSTribe SEQ	Arp/Seq	Tomohiro Nakamura		216
306	Electric Drum Kit	SFX/Perc	KORG Inc.		217
307	Fis Drumparts	SFX/Perc	KORG Inc.	A15	218
308	KICK BETA	SFX/Perc	VROMM		219
309	El Ritmo	SFX/Perc	VROMM		220
310	Agua de las cavernas	SFX/Perc	VROMM		221
311	KONG's Footstep	SFX/Perc	KORG Inc.	B15	Ver.2
312	Industrial Smash	SFX/Perc	Matt Pike	C15	Ver.2
313	Cockpit Emergency	SFX/Perc	Katsunori UJIE		Ver.2
314	Delay Modulator	SFX/Perc	KORG Inc.		Ver.2
315	Random Textures	SFX/Perc	Richard Devine		223
316	A bit dirty	SFX/Perc	VROMM		222
317	Feedback Loop	SFX/Perc	KORG Inc.		Ver.2
318	Epic 30s Riser	SFX/Perc	Matt Pike		Ver.2
319	INFINITY	SFX/Perc	Tomohiro Nakamura		225
320	Hot Revs	SFX/Perc	Luke Edwards		224
321	[TMP] Detune Sine	Template	Template	B16	226
322	[TMP] Detune Saw	Template	Template	A16	227
323	[TMP] Unison Saw	Template	Template		228
324	[TMP] Reso Noise	Template	Template		229
325	[TMP] Chord Hit	Template	Template	C16	230
326	[TMP] Velocity FM	Template	Template		231
327	[TMP] ZOP FM	Template	Template		232
328	[TMP] Harmonics Mod	Template	Template		233
329	[TMP] Modulator FM	Template	Template		234
330	[TMP] Pulse Width	Template	Template		240
331	[TMP] Ring Mod	Template	Template		236
332	[TMP] FM Sync	Template	Template		235
333	[TMP] Wavfolder Sync	Template	Template		238
334	[TMP] Wavfolder	Template	Template		237
335	[TMP] Filter FM	Template	Template		239
336	[TMP] Waveshape	Template	Template		Ver.2
337	[TMP] Delay Mod	Template	Template		Ver.2
338	[TMP] Comb Flanger	Template	Template		Ver.2
339	[TMP] Comb LFO	Template	Template		Ver.2
340	[TMP] Phaser Noise	Template	Template		Ver.2

No.	Name	Category	Programmer	Favorite	V1 No.**
341	[TMP] EG ADSR	Template	Template		241
342	[TMP] Pitch EG Perc	Template	Template		242
343	[TMP] Random Pan	Template	Template		243
344	[TMP] OP Filter Mono	Template	Template		244
345	[TMP] OP Mode Check	Template	Template		245
346	[TMP] Quadra LFOs	Template	Template		246
347	[TMP] Effect LFO	Template	Template		247
348	[TMP] User Filter Ping	Template	Template		248
349	[TMP] C4 Key Split	Template	Template		249
350	[TMP] SEQ Key Trig	Template	Template		250

* 351–500: Initialized Program

V1 No. column means number on old Preset Program ver1.0.

All Programs were made by Francis Preve, Richard Devine, Matt Pike, VROMM, Tomohiro Nakamura, Minoru Koike, Katsunori UJIE, Dean Walliss, Luke Edwards and KORG Inc.

For more information about the authors please visit:

Francis Preve

<http://www.francispreve.com>

Richard Devine

<https://www.facebook.com/RichardDevineMusic/>

Matt Pike

<http://www.mattpikesounddesign.com/>

VROMM

<https://www.facebook.com/vrommaudio>

Tomohiro Nakamura (aka Ghostradioshow)

<https://www.youtube.com/user/ghostradioshow>

Minoru Koike

https://soundcloud.com/k_minor2

Katsunori UJIE

<https://www.sitekatsunorijie.com>

Favorite List

No.	Prog	Name	Category
A01	146	Rasp & Static	SlowSynth
A02	121	Filtered Saws	FastSynth
A03	022	Comb Piano	Keyboard
A04	107	MOD Storm	Motion
A05	241	Mod Saw Lead	Lead
A06	071	Lonely Star	Bell/Decay
A07	290	WS Pulse Anthem	Arp/Seq
A08	192	Breezy Pad	Pad/Strings
A09	269	Arp Swirls	Arp/Seq
A10	099	Pluck Drip	Motion
A11	046	Tone Wheel Organ	Keyboard
A12	174	Ghost Voices	SlowSynth
A13	238	Thick Screamer	Bass
A14	057	Strum Down	Keyboard
A15	307	Fis Drumparts	SFX/Perc
A16	322	[TMP] Detune Saw	Template
B01	168	Lab Coats	SlowSynth
B02	117	Dyno FM Brass	FastSynth
B03	003	FM E.Piano Basic	Keyboard
B04	104	Organic Glow	Motion
B05	246	C.C.M.M SynLead	Lead
B06	087	Snow Ball	Bell/Decay
B07	293	Quadratic Chord Pulse	Arp/Seq
B08	194	Comb Strings	Pad/Strings
B09	278	NOS	Arp/Seq
B10	112	Fairy Tweets	Motion
B11	037	Metalic Pluck	Keyboard
B12	160	Feel The Pump	SlowSynth
B13	210	90's House Bass	Bass
B14	061	Syn Marimba	Bell/Decay
B15	311	KONG's Footstep	SFX/Perc
B16	321	[TMP] Detune Sine	Template

No.	Prog	Name	Category
C01	156	Distant Wave Voices	SlowSynth
C02	128	5th Stab	FastSynth
C03	001	Dat Electric Piano	Keyboard
C04	097	Cycles	Motion
C05	266	Purple Dist EG	Lead
C06	080	Shimmer & Folder	Bell/Decay
C07	272	Hybrid Pluck	Arp/Seq
C08	184	opsix Concrete	Pad/Strings
C09	303	Table Tapping	Arp/Seq
C10	100	Rand Spacing Pulses	Motion
C11	052	OPcordion	Keyboard
C12	173	Star Pad	SlowSynth
C13	207	FM Slap	Bass
C14	060	Distant Memories	Keyboard
C15	312	Industrial Smash	SFX/Perc
C16	325	[TMP] Chord Hit	Template

* Favorite D01–D16 are Reserved Slot.

MIDI Implementation Chart

Function...		Transmitted	Recognized	Remarks
Basic Channel	Default	1-16	1-16	Memorized
	Changed	1-16	1-16	
Mode	Default		3	
	Messages Altered	X *****	X	
Note Number		0-127	0-127	
	True voice	*****	0-127	
Velocity	Note On	O 9n, V=1-127	O 9n, V=1-127	Received Note Off Velocity values are clipped at 64
	Note Off	O 8n, V=1-64	O 8n, V=0-127	
After Touch	Key's	X *4	O	Assignable for Virtual Patch sources
	Channel	O *4	O	
Pitch Bend		O	O	
Control Change	0, 32	O	O	Bank Select (MSB, LSB)
	1	O	O	Modulation
	5	O	O	"Glide Time" in the Voice Assign page
	7	X	O	Volume
	10	X	O	Pan
	11	X	O	Expression
	64	O	O	Damper
	65	O*1	O*2	"Glide Mode" in the Voice Assign page
	66	X	O	Sostenuto
	67	X	O	Soft
	70	O	O	"Algorithm" in the Home/Algorithm page
	71	O	O	"Resonance" parameter in the Filter page
	73	O	O	"Attack" in the Home/Algorithm
	74	O	O	"Cutoff" in the Filter page
	79	O	O	"Decay/Release" in the Home/Algorithm page
	81	O	O	"FX1" in the Home/Algorithm page
	82	O	O	"FX2" in the Home/Algorithm page
	83	O	O	"FX3" in the Home/Algorithm page
	102-107	O	O	OP1-6 Level sliders
	108-113	O	O	OP1-6 Ratio knobs
1-119	X	O	Assignable for Virtual Patch sources	
1-119	O	X	Transmittable from Motion Sequencer	
120, 121	X	O	All Sounds Off, Reset All Controllers	
Program Change		O 0-99	O 0-99	
	True Number	*****	0-99	
System Exclusive		O	O	*3, *5
System Common	Song Position	X	X	
	Song Select	X	X	
	Tune Request	X	X	
System Real Time	Clock	O	O	
	Commands	O	O	
Aux Messages	Local On/Off	X	X	
	All Notes Off	X	O 123-127	
	Active Sensing	O	O	
	System Reset	X	X	

Notes

- *1: Off: 0, Legato: 64, On: 127
- *2: After setting "Legato" on the front panel, 0-63: Off, 64-127: Legato. Otherwise 0-63: Off, 64-127: On.
- *3: Supports universal system exclusive messages device inquiry, master volume, master fine tuning, and master coarse tuning.
- *4: Only the opsix SE can send aftertouch.
- *5: Supports MIDI 2.0 Property Exchange.

Mode 1: Omni On, Poly
 Mode 3: Omni Off, Poly

Mode 2: Omni On, Mono
 Mode 4: Omni Off, Mono

O: Yes
 X: No

KORG INC.

4015-2 Yanokuchi, Inagi-City, Tokyo 206-0812 JAPAN

© 2020 KORG INC.

www.korg.com

Published 10/2023